



# Harry Potter

WIZARDING  
WORLD

76426



Q LEGO® Builder



LEGO.com/sustainable-packaging



FR **DONNEZ**  
OU  
**RECYCLEZ**

 OU  OU 

ASSOCIATION MAGASIN DÉCHÈTERIE

Adresses sur [quefairedemesdechets.fr](http://quefairedemesdechets.fr)

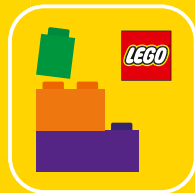

LEGO® Builder

# BUILDER



Apple and the Apple logo are trademarks of Apple Inc., registered in the U.S. and other countries and regions. App Store is a service mark of Apple Inc. Google Play and the Google Play logo are trademarks of Google LLC. Tencent and the Tencent logo are trademarks of Tencent Inc.

[LEGO.com/devicecheck](https://LEGO.com/devicecheck)

**EN** Ask parents' permission before going online | **DE** Eltern um Erlaubnis bitten, bevor du online gehst | **FR** Demande l'autorisation d'un parent avant d'aller en ligne | **IT** Chiedi il permesso ai tuoi genitori prima di andare online | **ES** Pídeles permiso a tus papás antes de conectarte a Internet | **PT** Peça autorização aos pais antes de acederes online | **ZH** 上网前应先征得父母的同意 | **PL** Poproś rodziców o zgodę, zanim wejdiesz do Internetu | **CS** Než půjdeš na internet, požádej rodiče o svolení | **SK** Skôr než pôjdeš na internet, vypýtaj si povolenie od rodičov | **HU** Kérj szülői engedélyt, mielőtt online csatlakoznál! | **RO** Cere permisiunea părinților înainte de a te conecta online | **BG** Поискайте разрешение от родител, преди да влезете онлайн | **LV** Pirms došanās tiešsaistē palūdz atļauju vecākiem | **ET** Enne Interneti kasutamist küsi vanematelt luba | **LT** Prieš prisijungdami prie interneto, atsiklausite tėvų



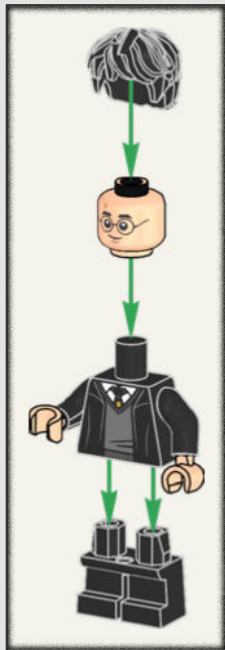

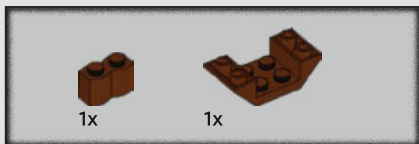

1

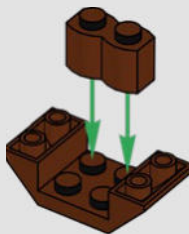



2

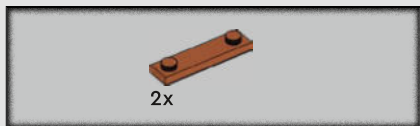
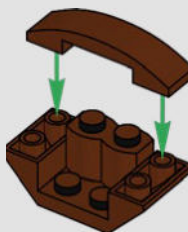

3

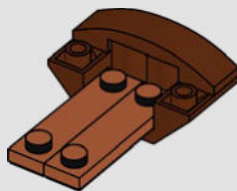

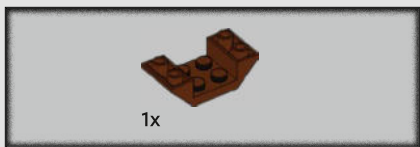

4

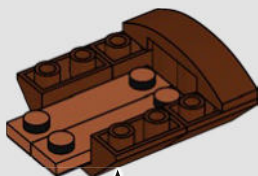
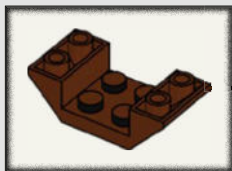

5

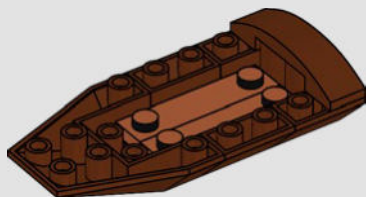





6

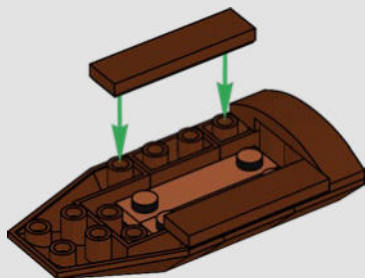

7

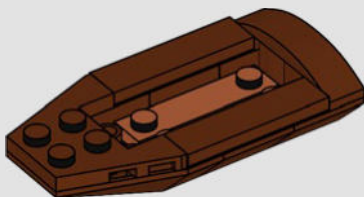



8

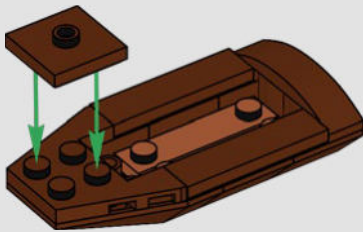

9

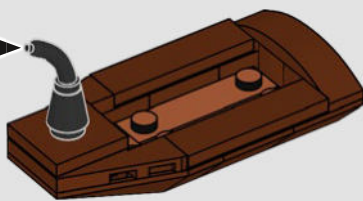
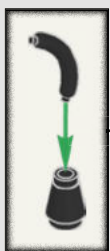



# 10

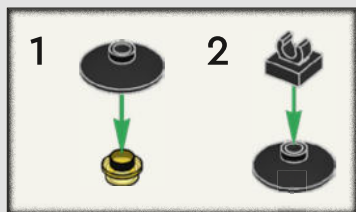

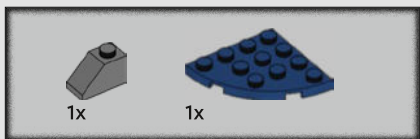
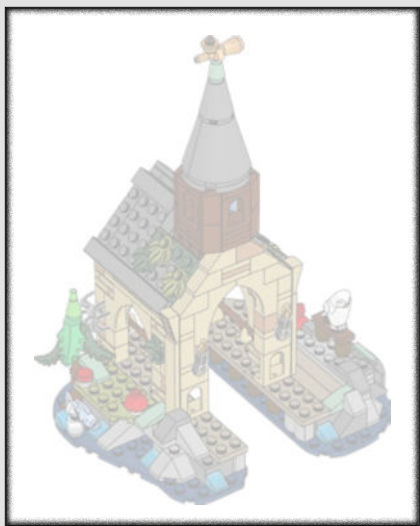

1

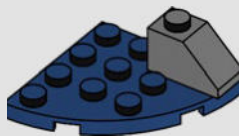



2

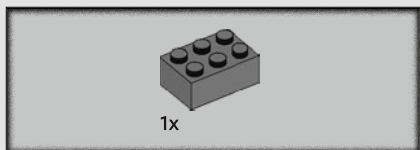

3

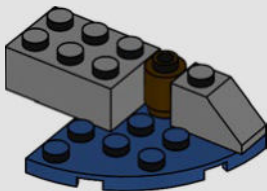



4

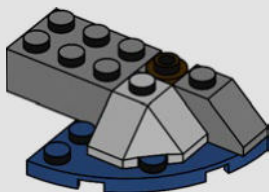

5

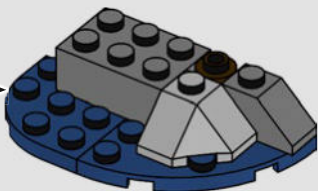
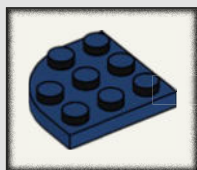

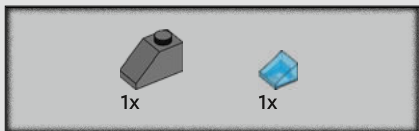

6

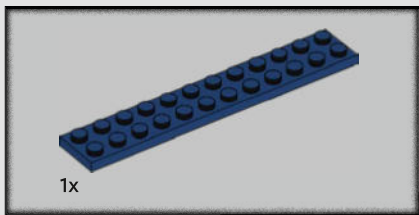

7

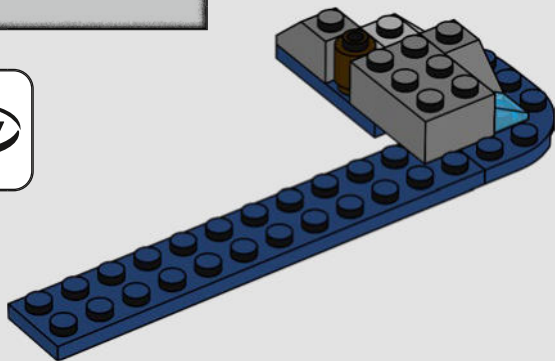

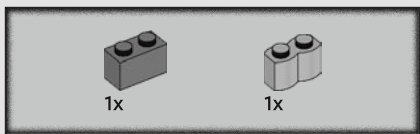

8

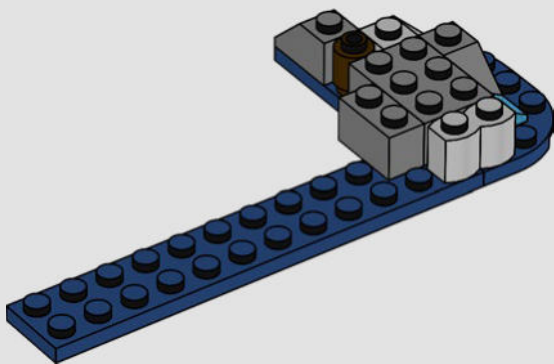





9

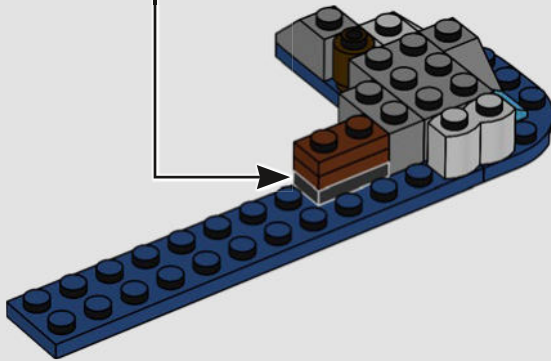
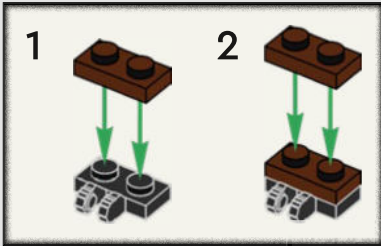

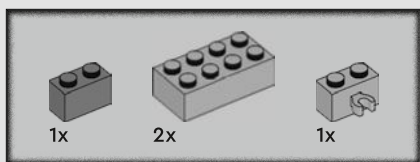

10

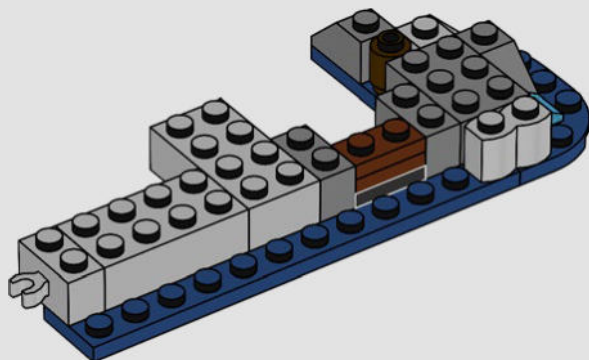

11

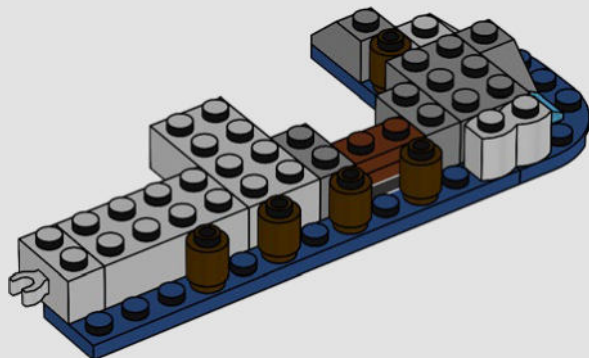

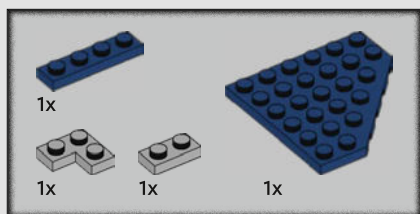

# 12

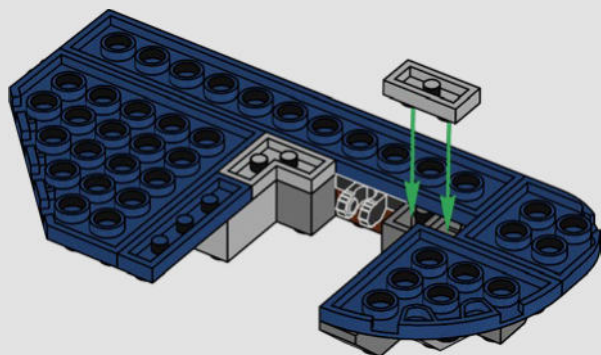

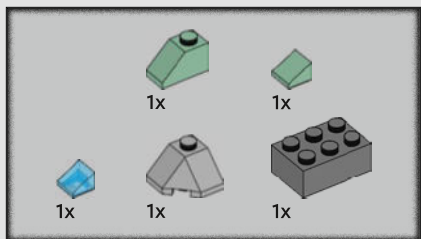

13

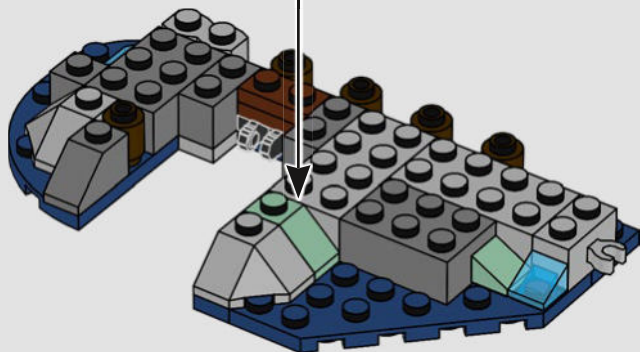
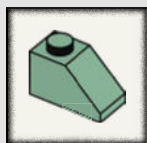

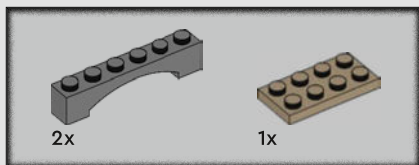

14

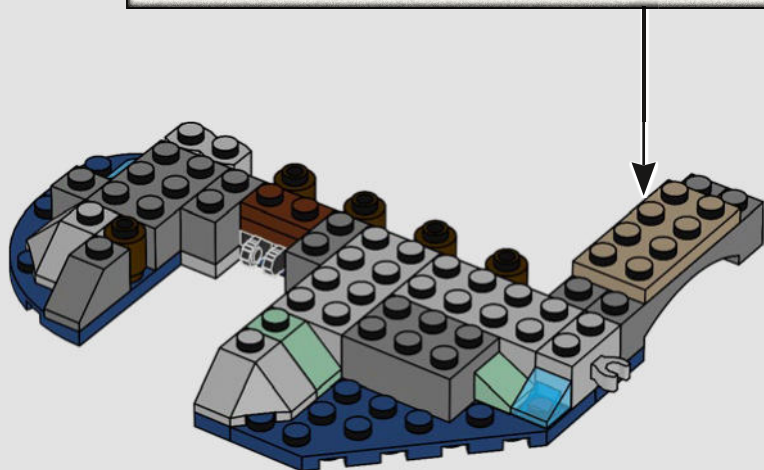
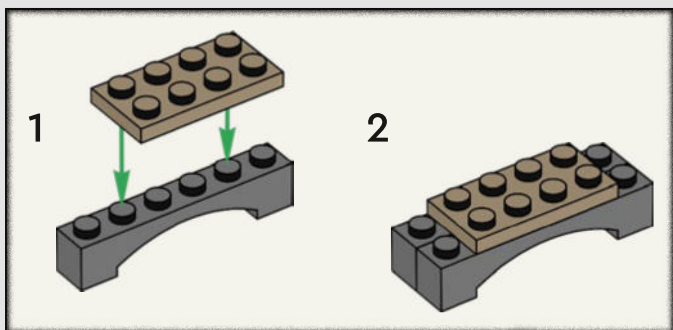

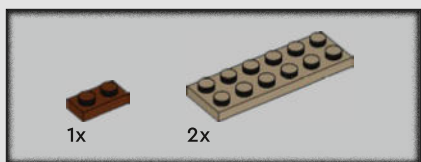

15

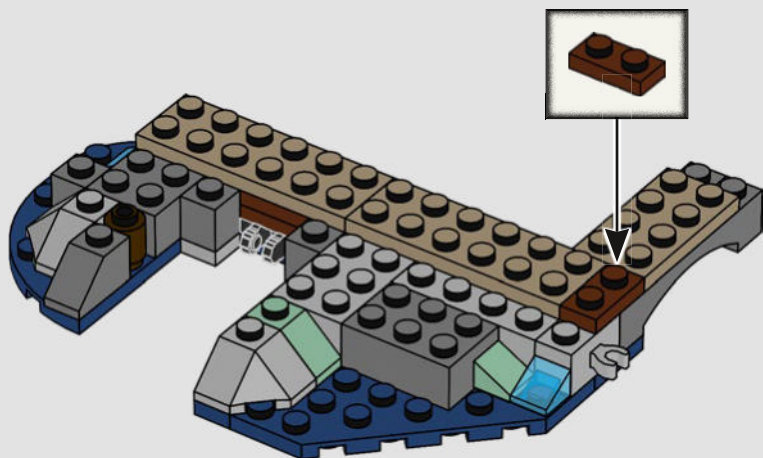

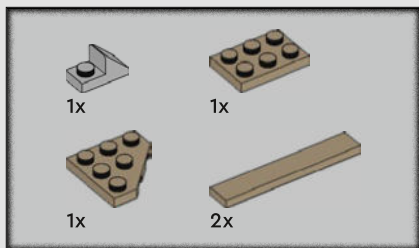

16

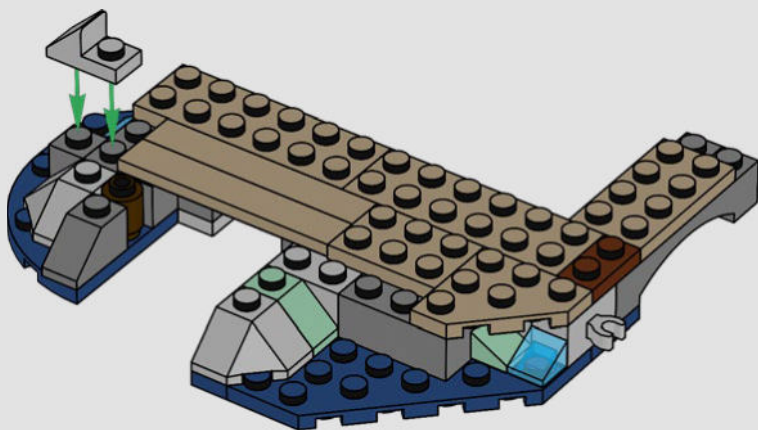

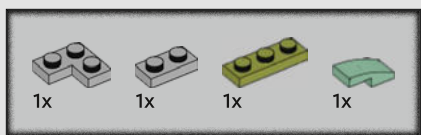

17

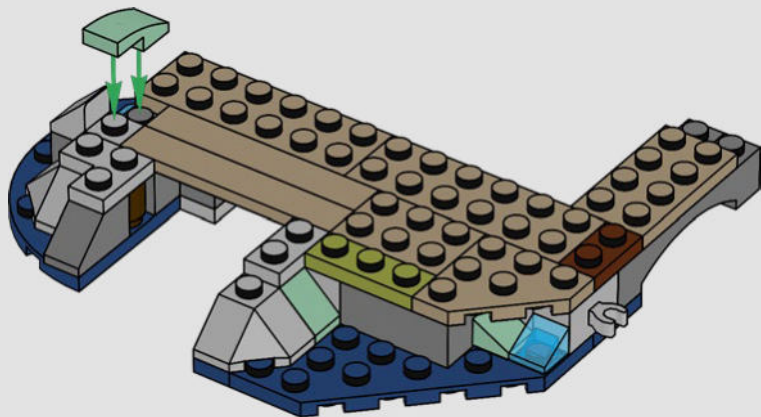



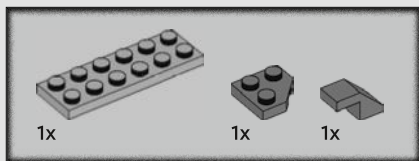

18

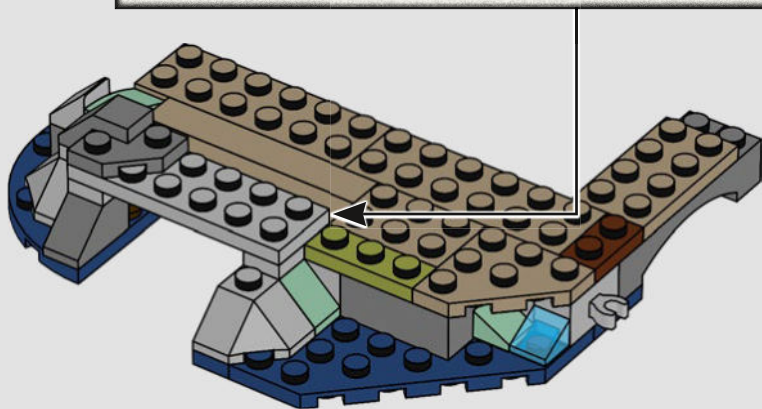
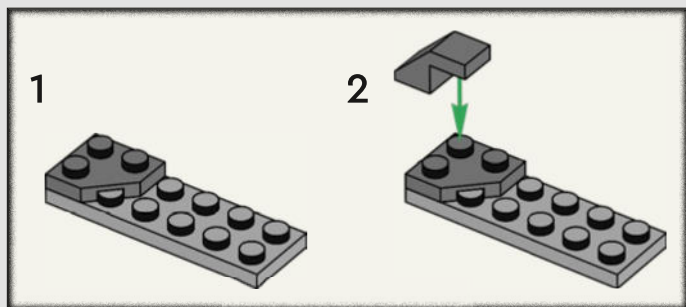

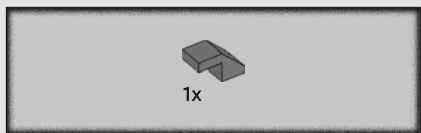

19

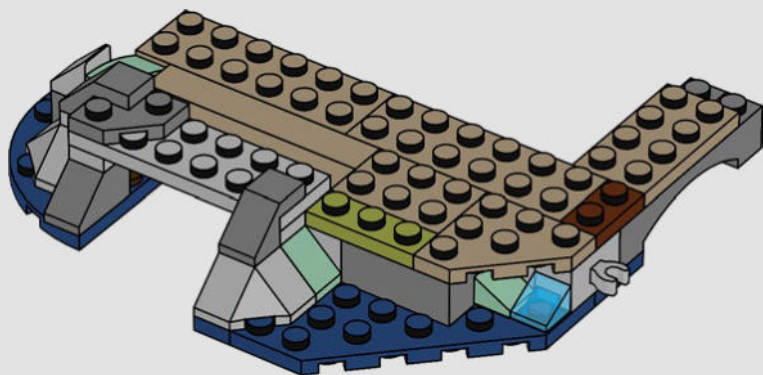

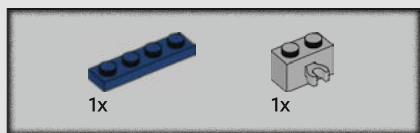
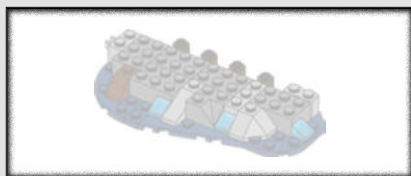

20

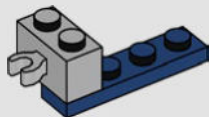

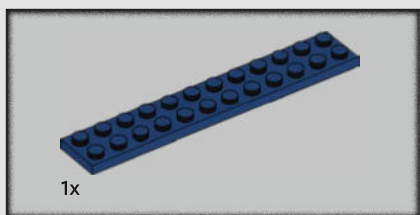

21

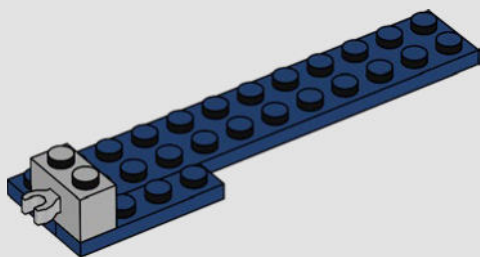

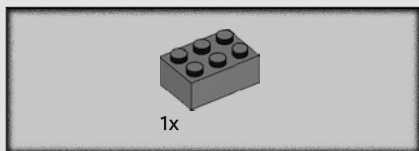

22

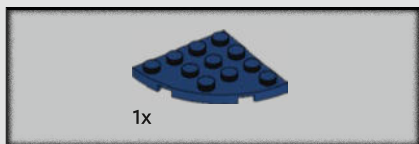
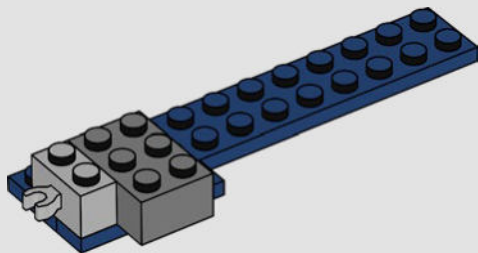

23

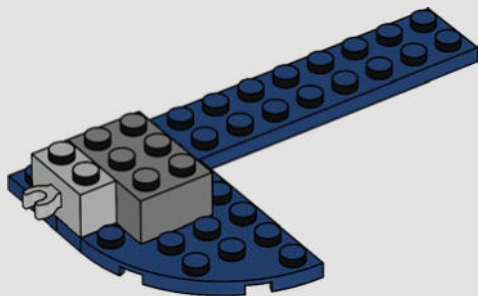



24

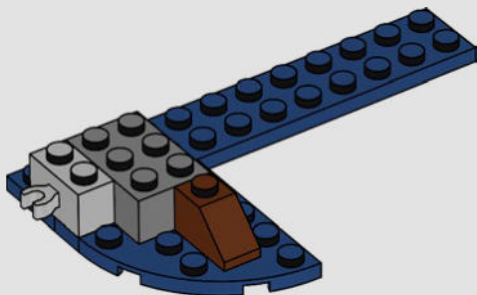



25

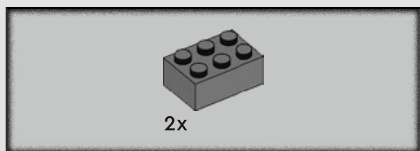
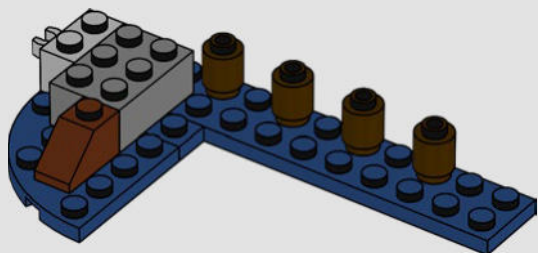

26

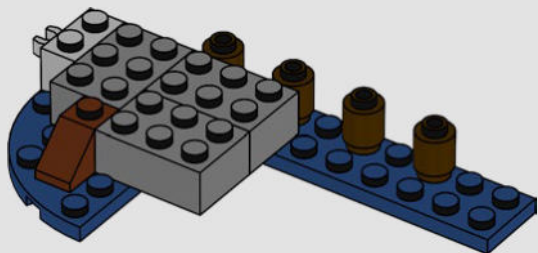



27

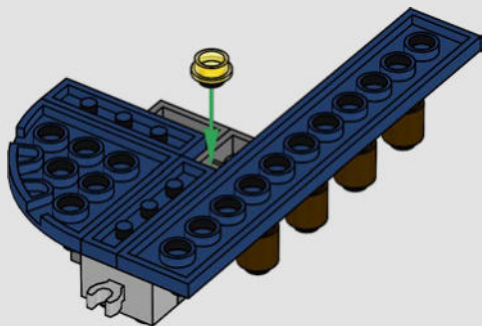



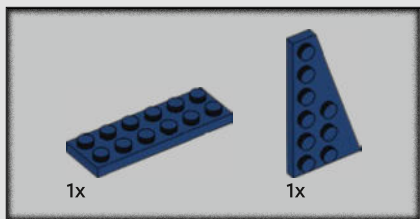

28

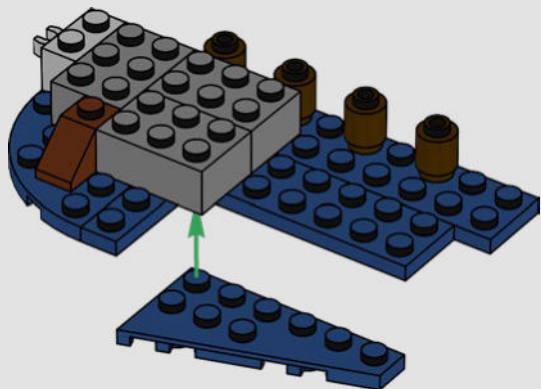

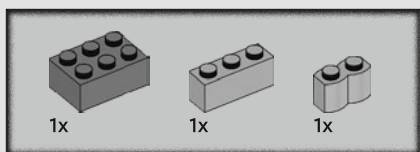

29

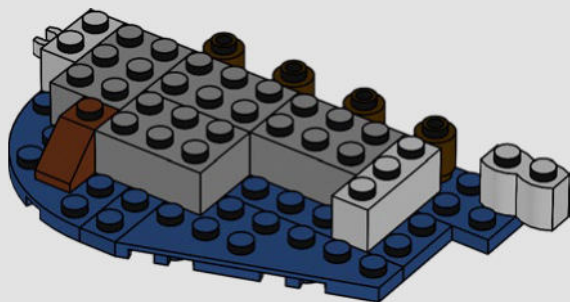

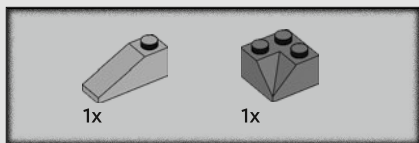

30

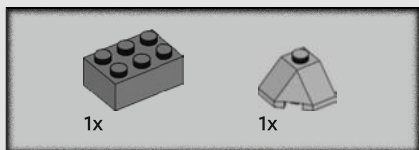
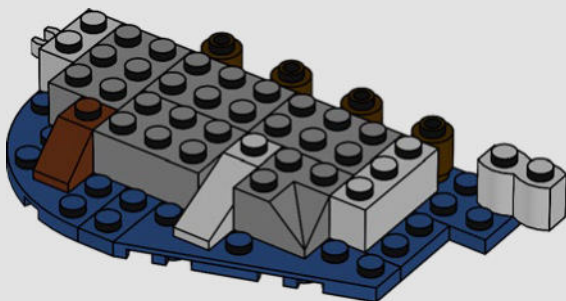

31

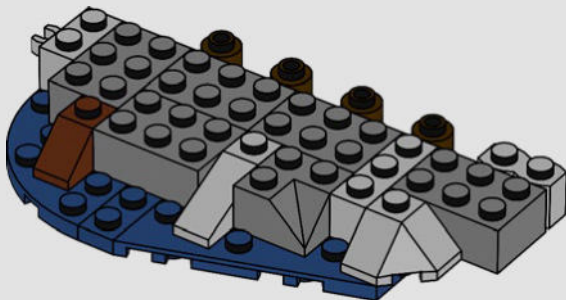

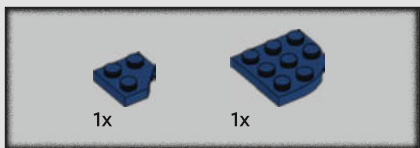

32

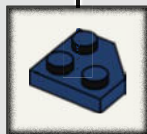
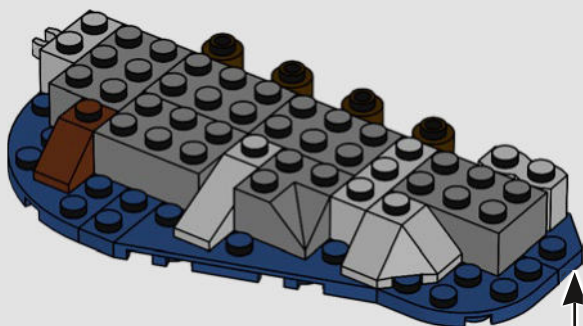



3x

33

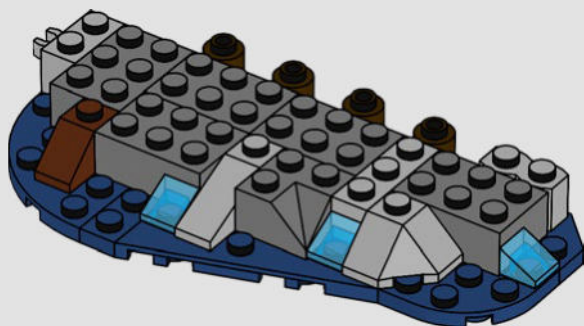

34

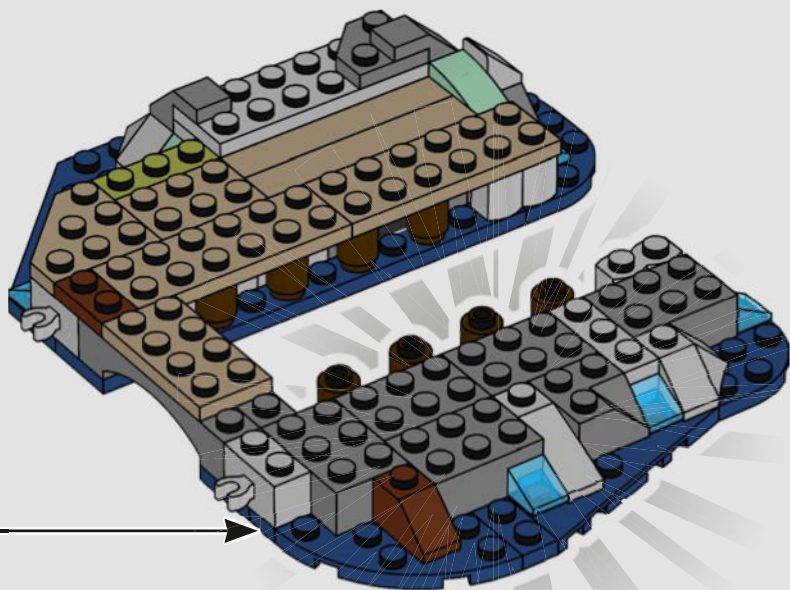

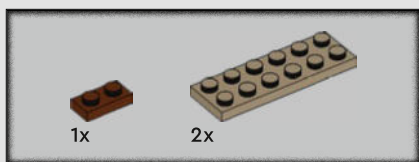

35

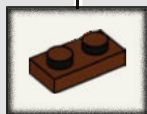
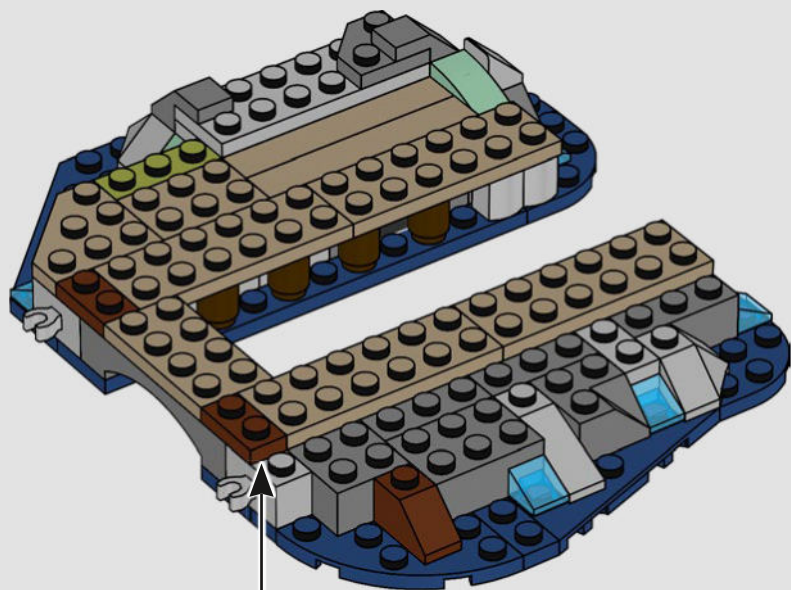

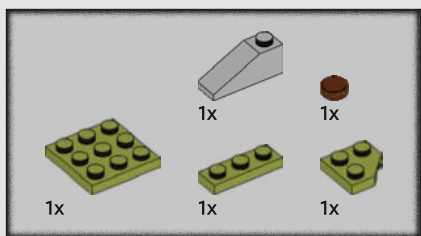

36

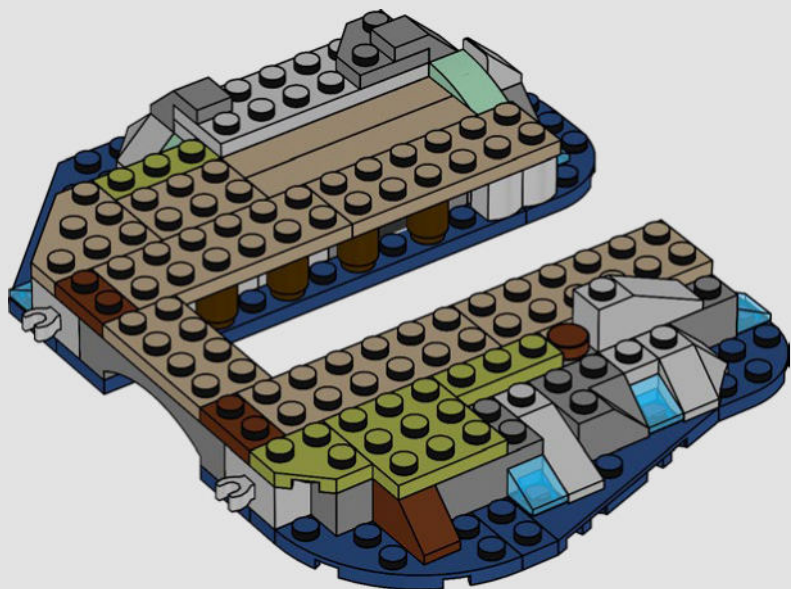





37

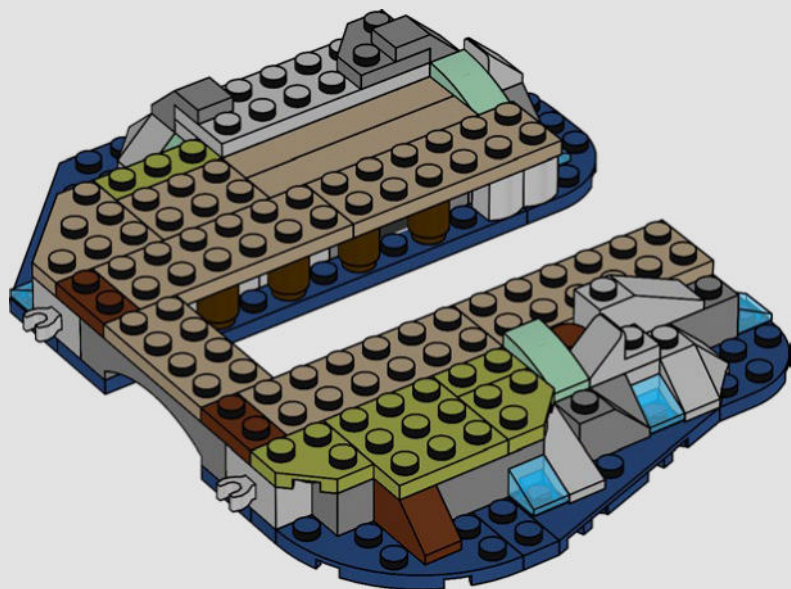

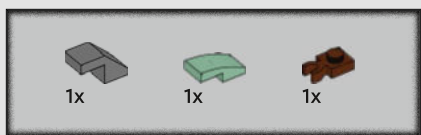

38

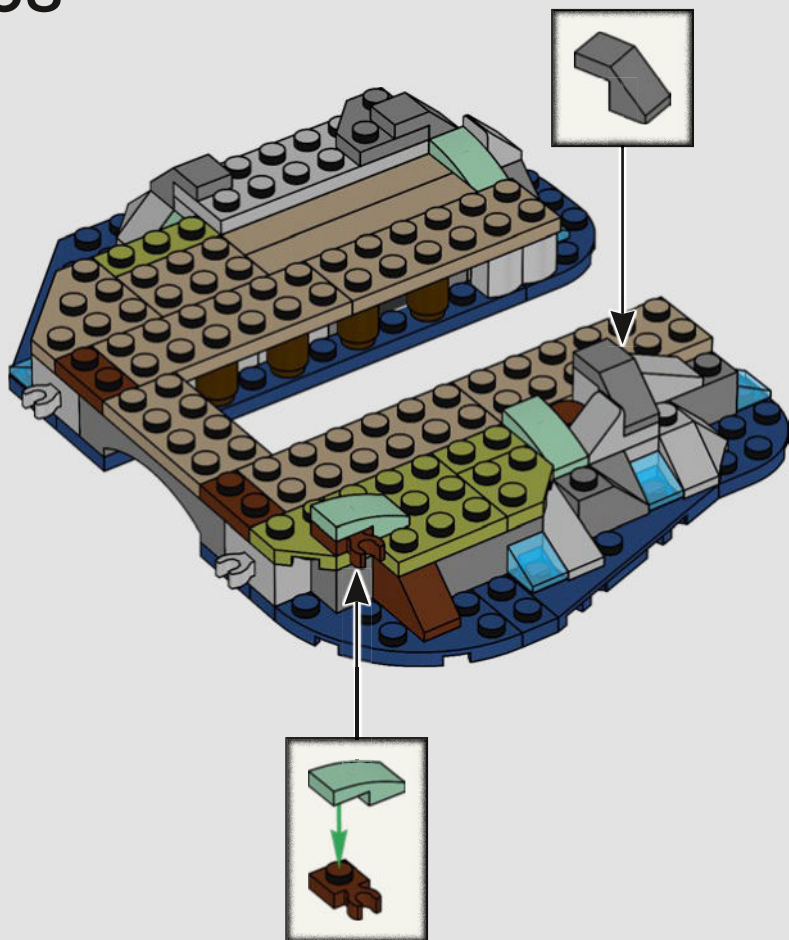

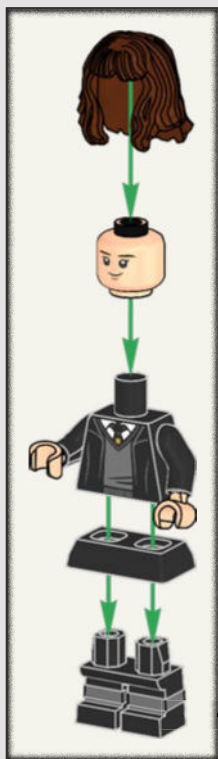

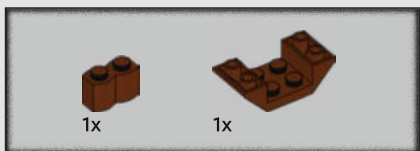

39

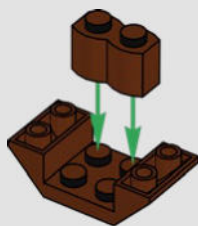



40

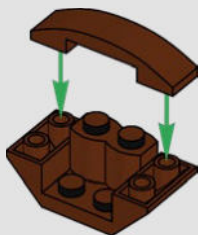

41

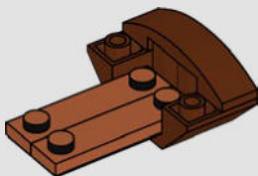

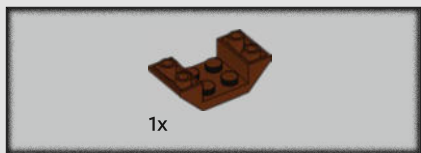

42

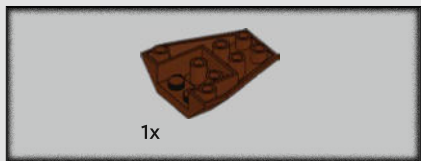
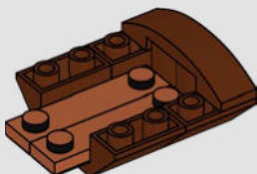
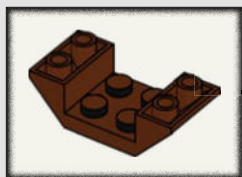

43

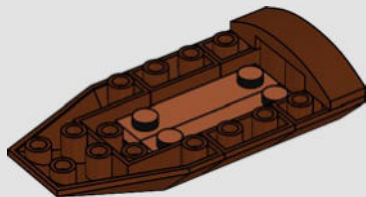



44

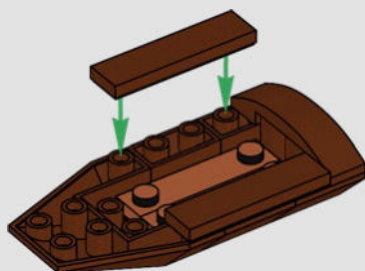

45

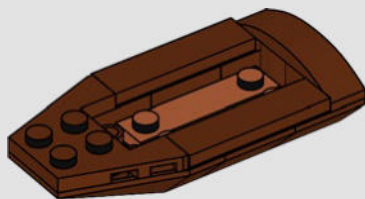



46

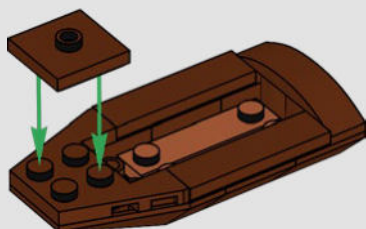



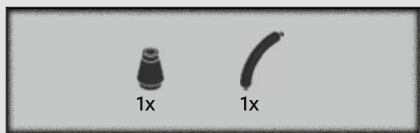

47

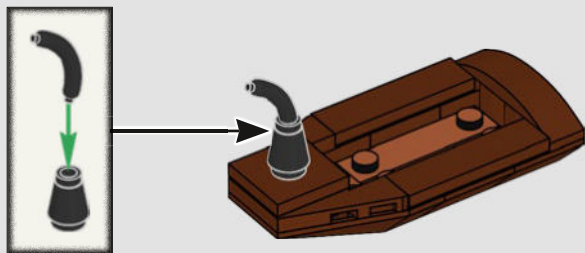

48

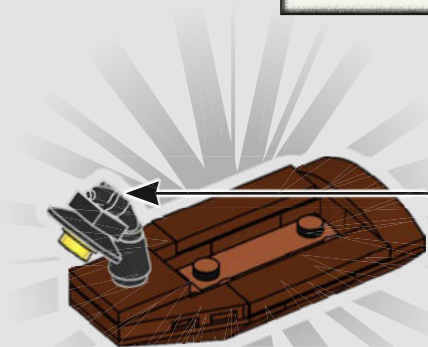
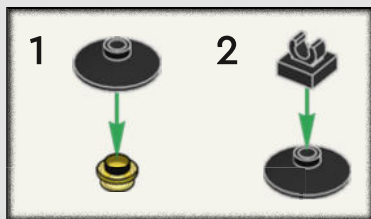

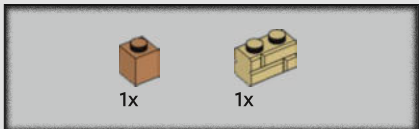
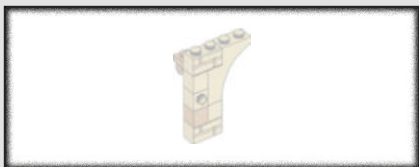

49

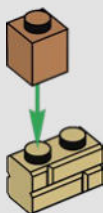

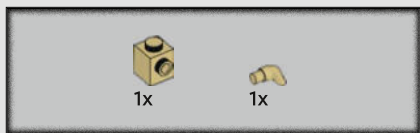

50

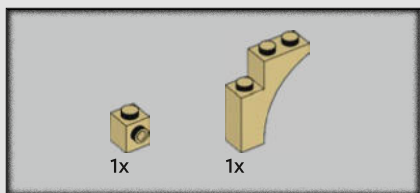
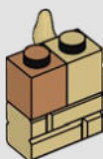
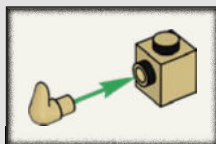

51

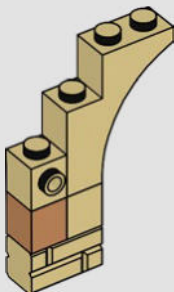



52

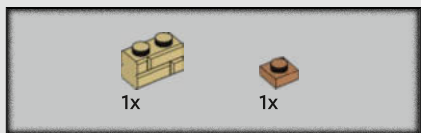
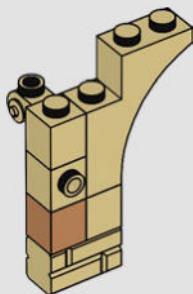

53

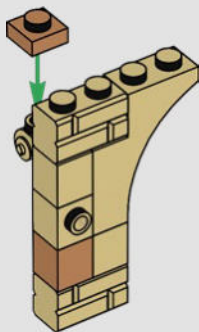

54

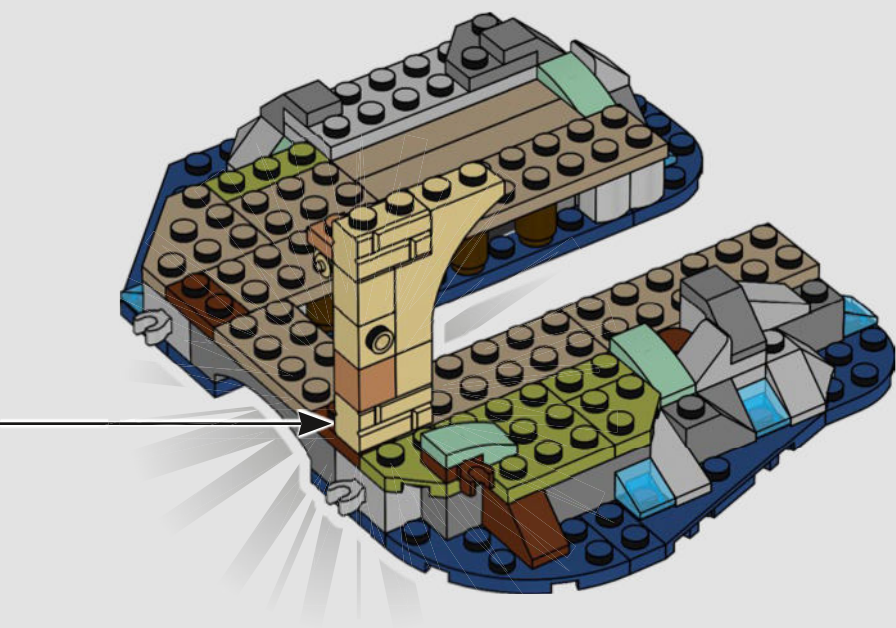

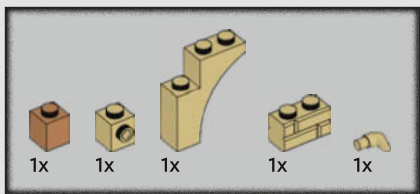

# 55

1

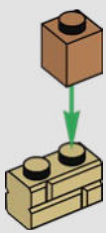

2

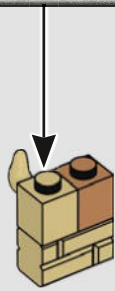
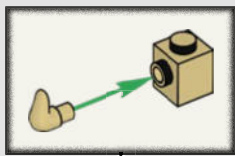

3

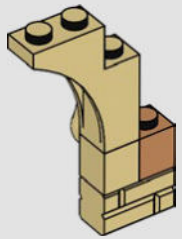

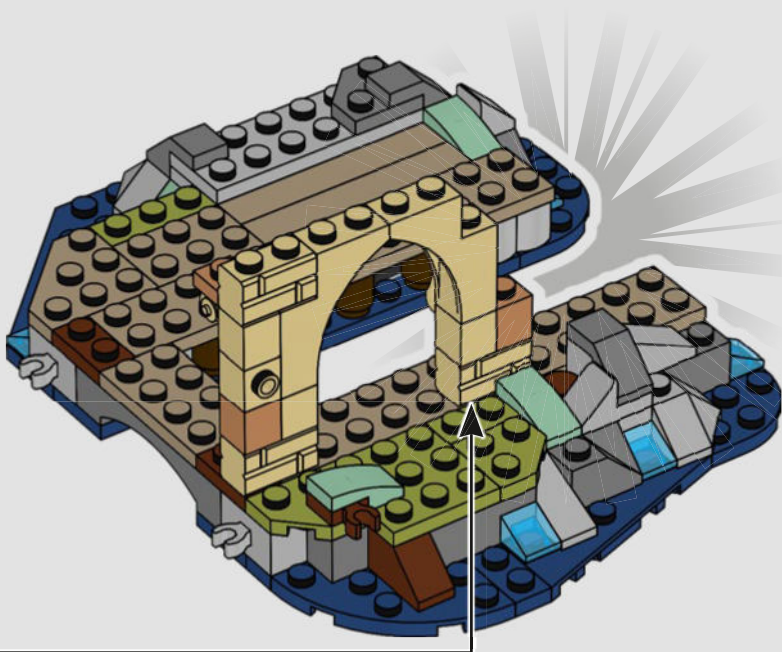



1x

# 56

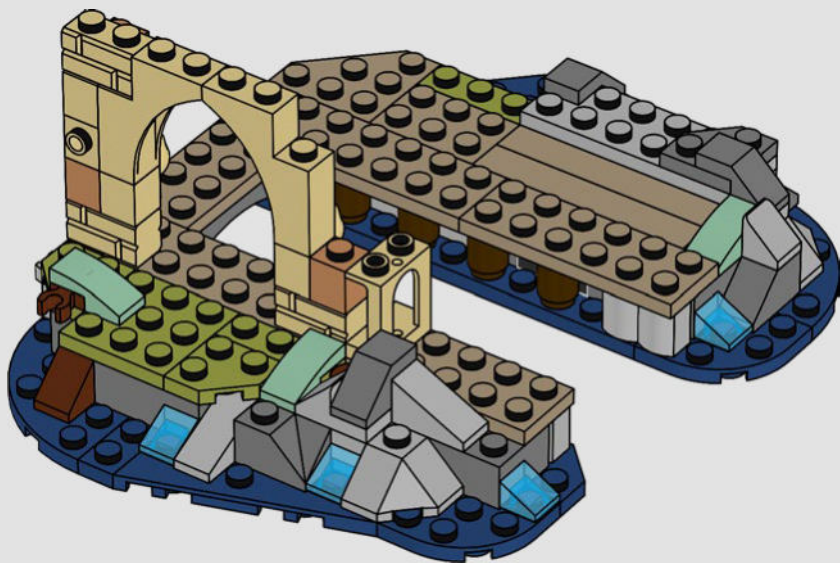



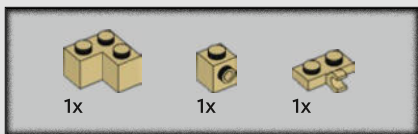

57

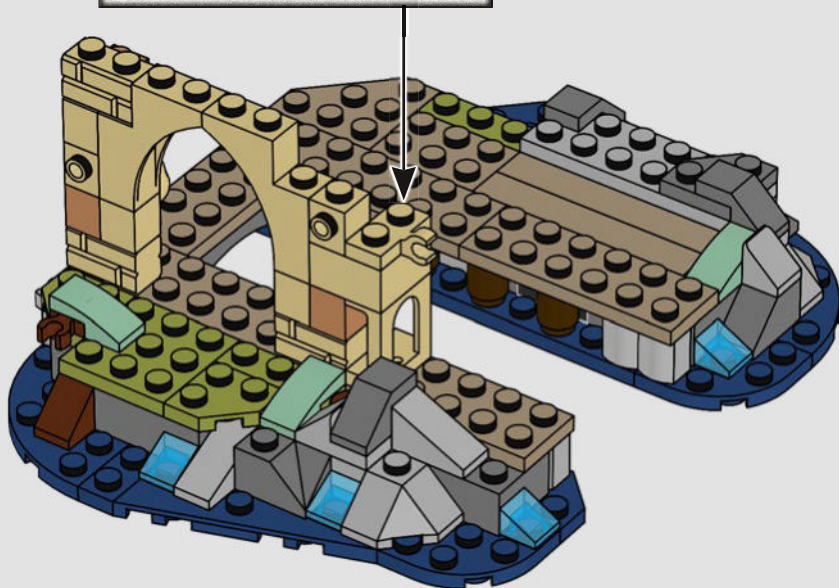
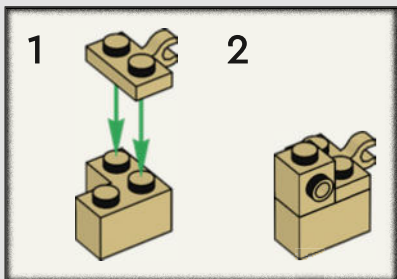

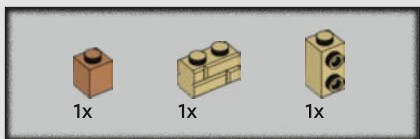

58

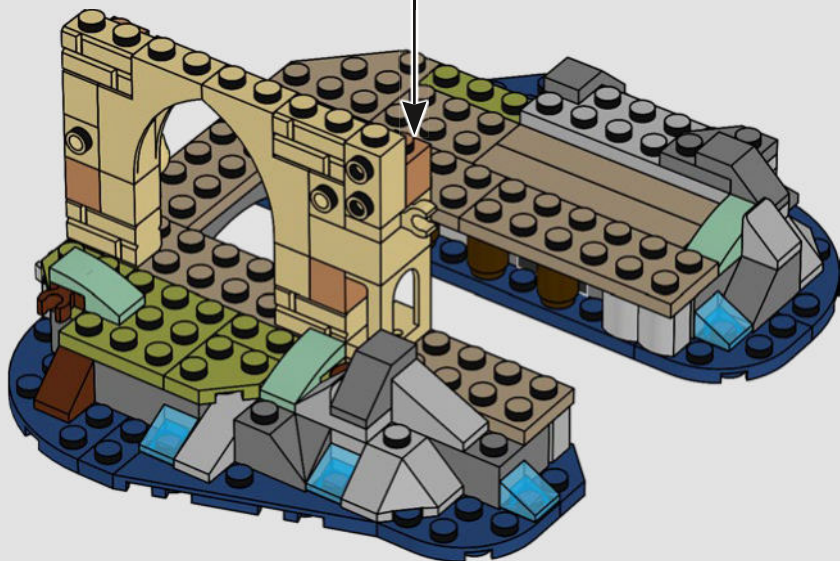

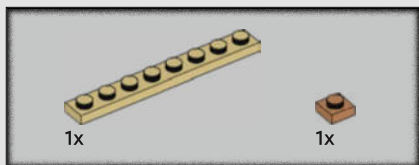

59

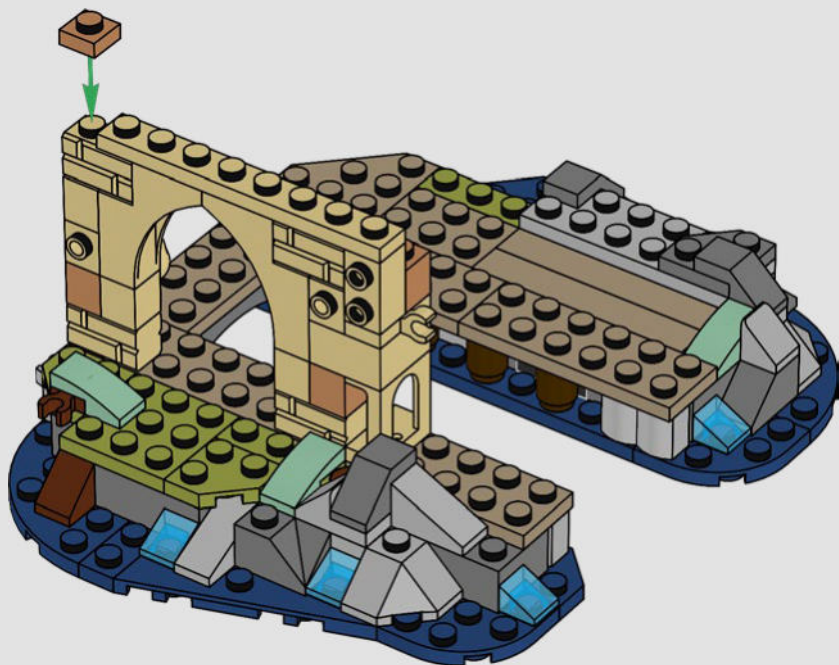

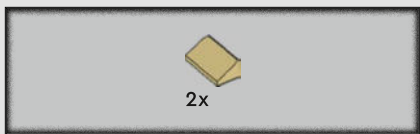

60

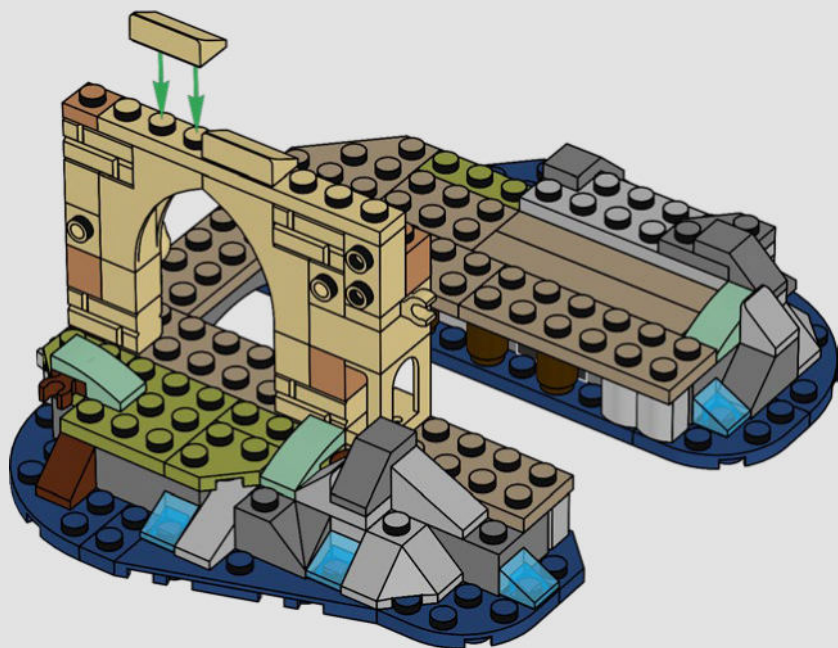

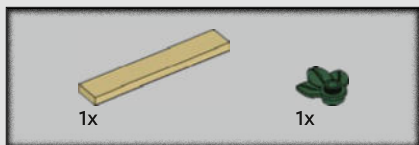

61

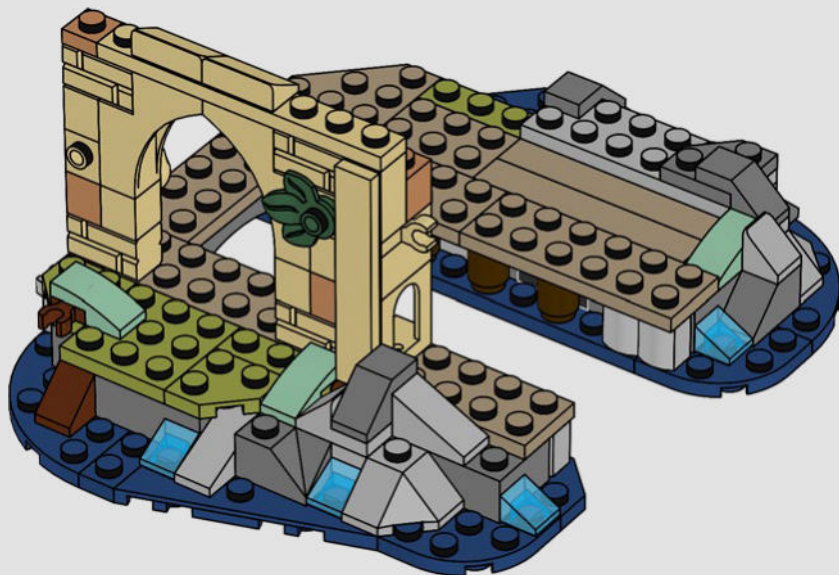



2x



1x



1x

# 62

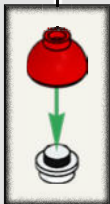
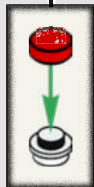
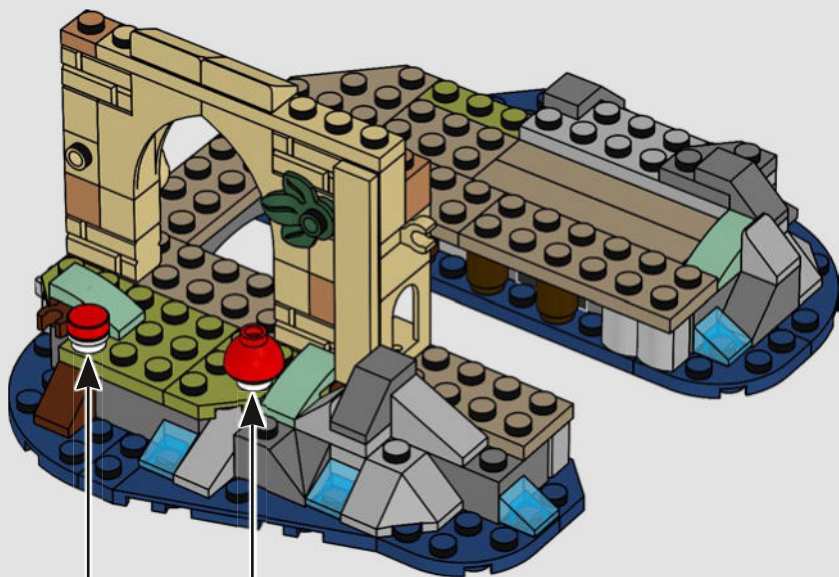



63

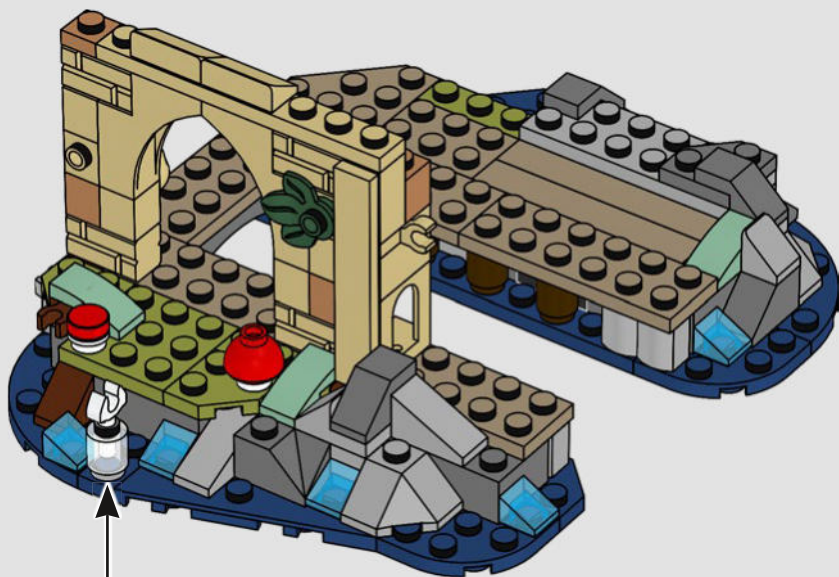

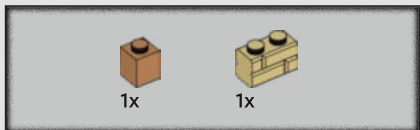
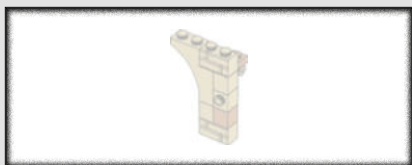

64

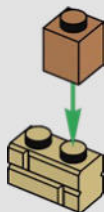



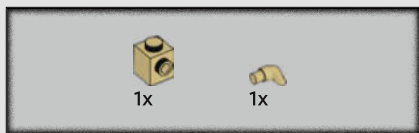

65

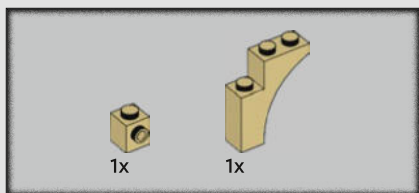
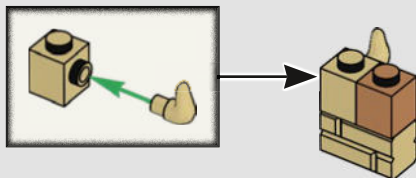

66

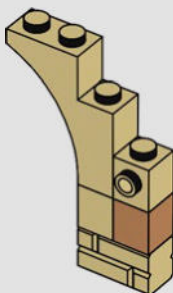

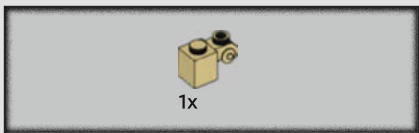

67

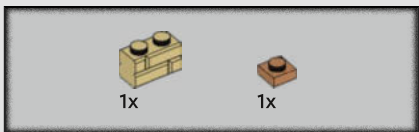
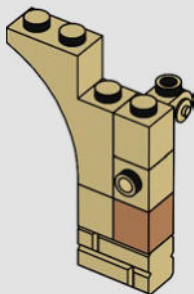

68

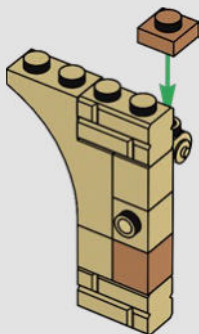

69

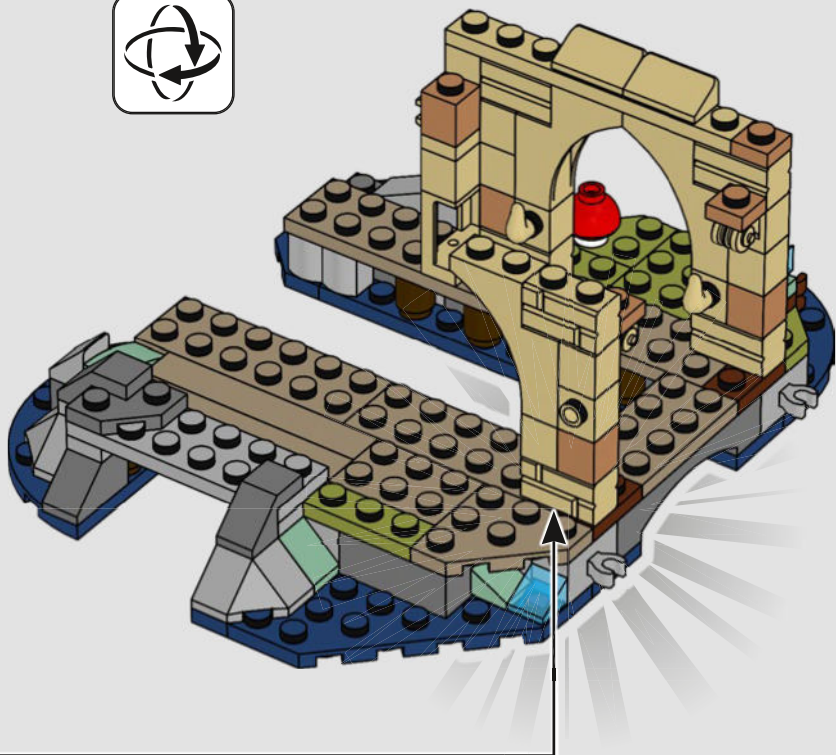

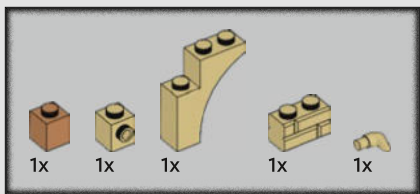

70

1

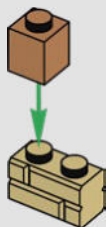

2

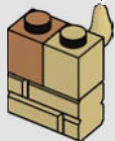
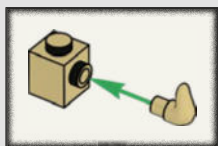

3

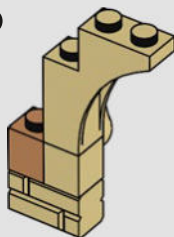

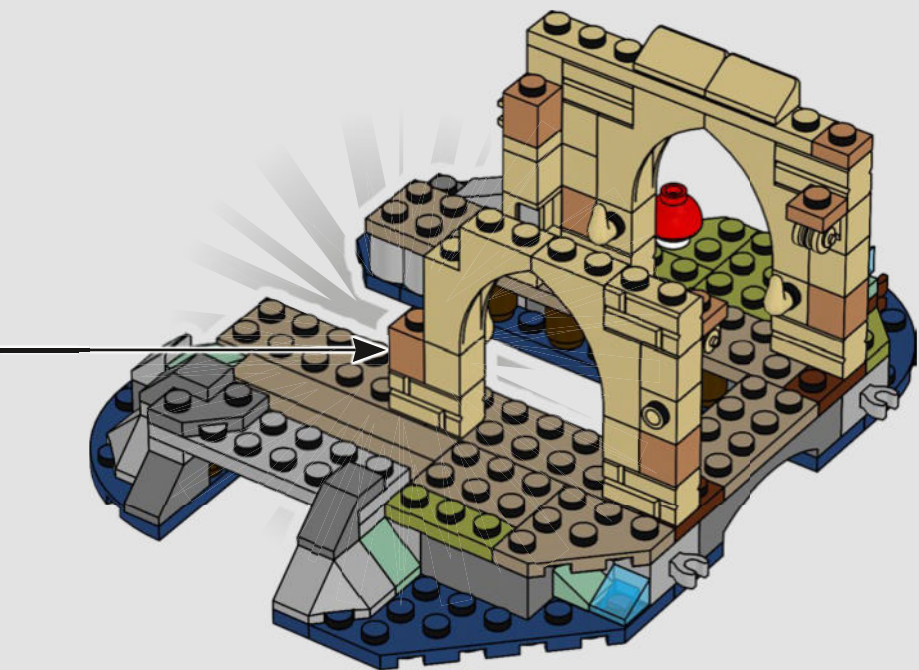

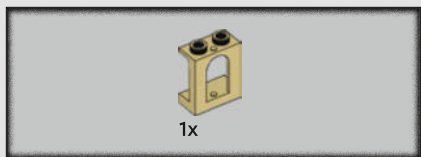

71

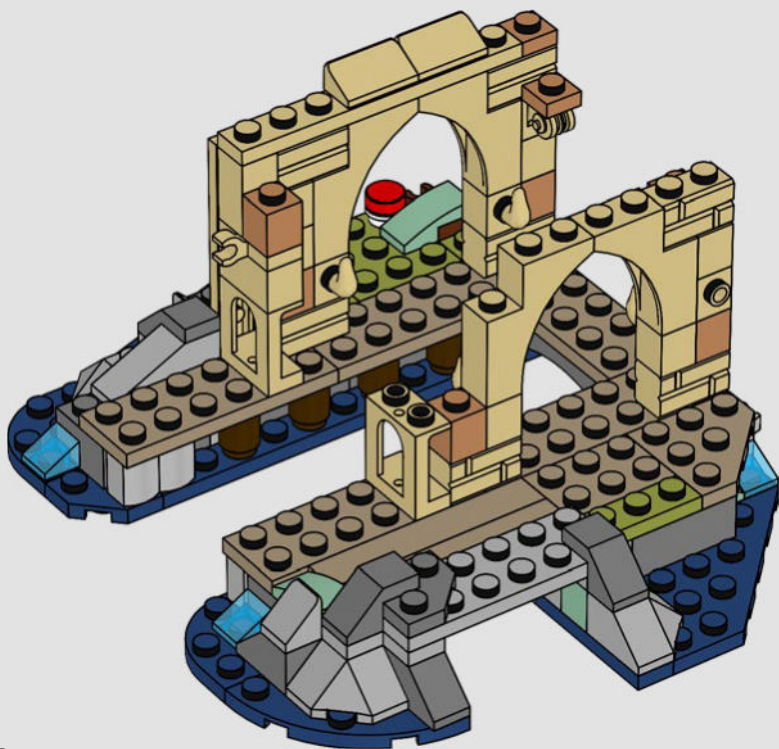

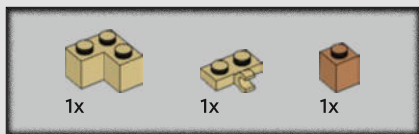

72

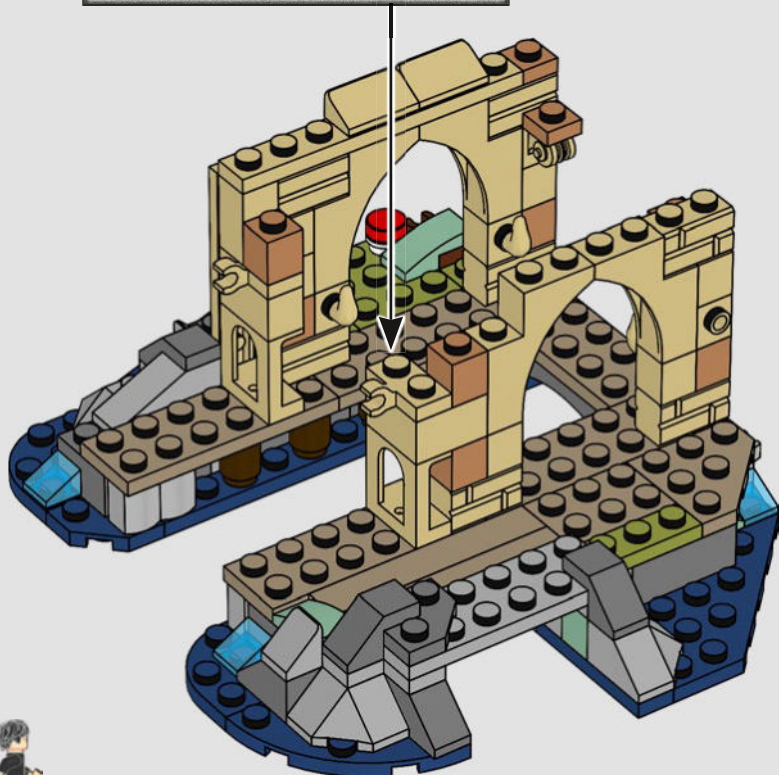
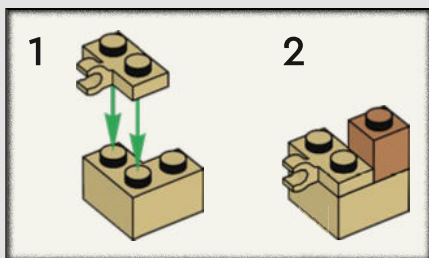

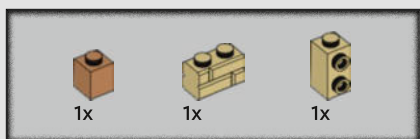

73

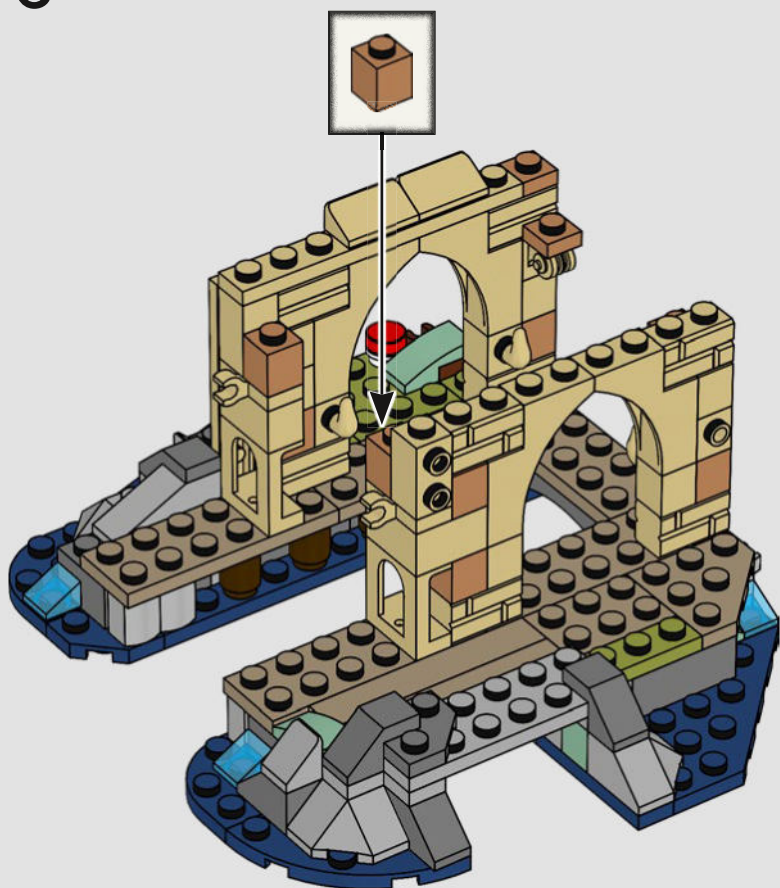



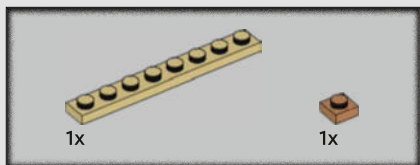

74

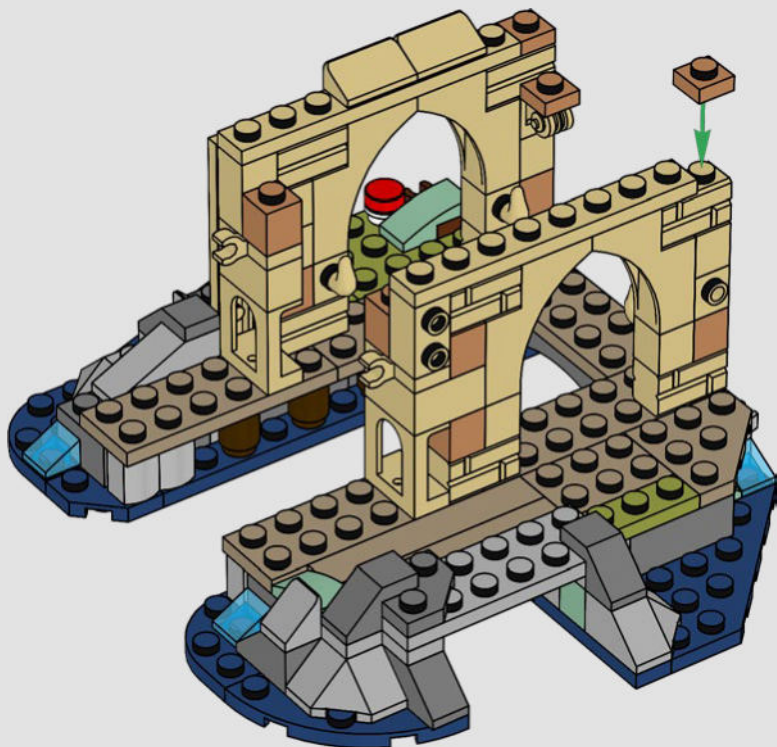

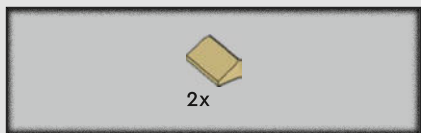

75

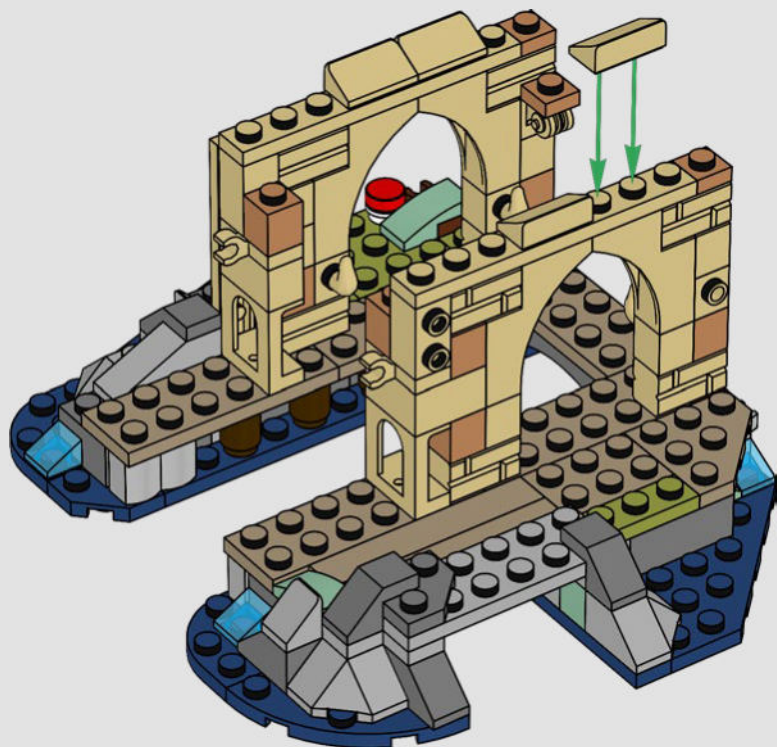

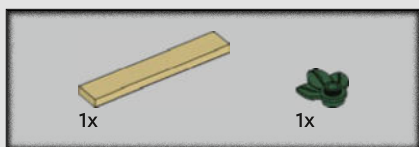

76

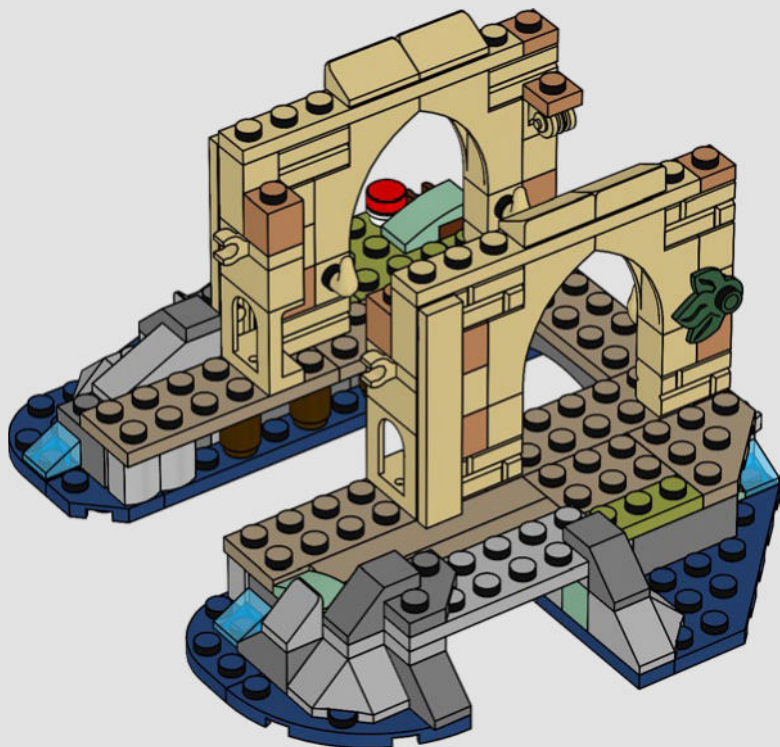

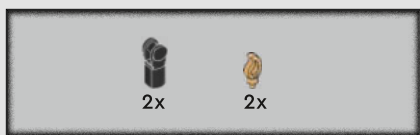

77

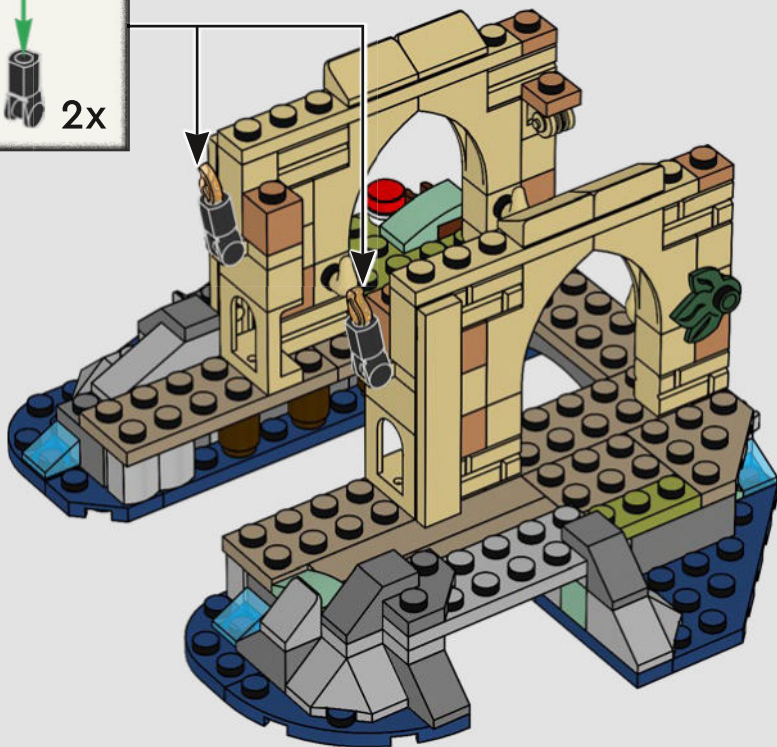
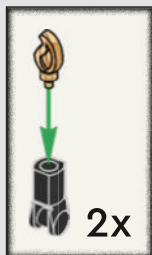

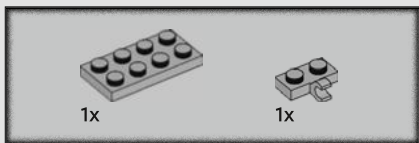

78

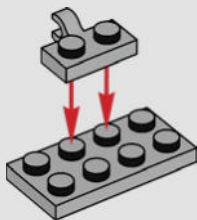

79

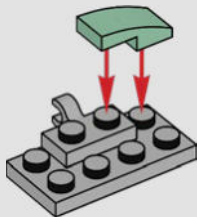

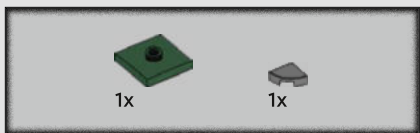

80

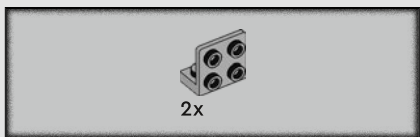
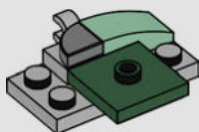

81

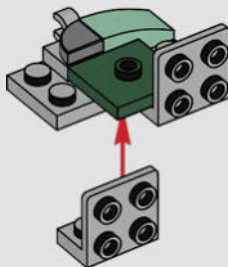

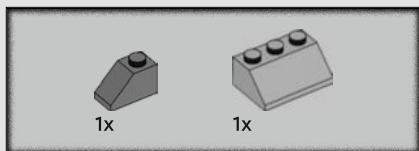

82

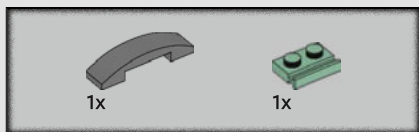
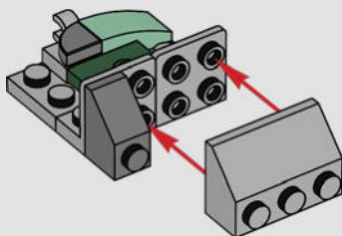

83

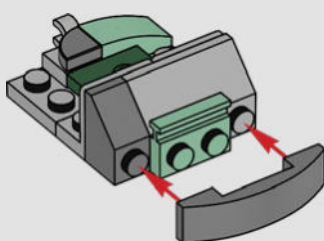

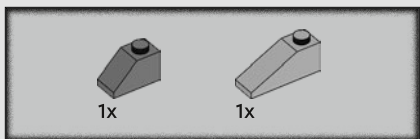

# 84

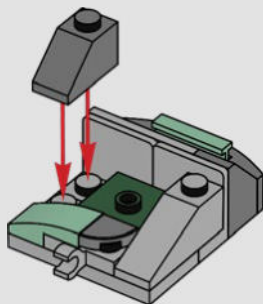

# 85

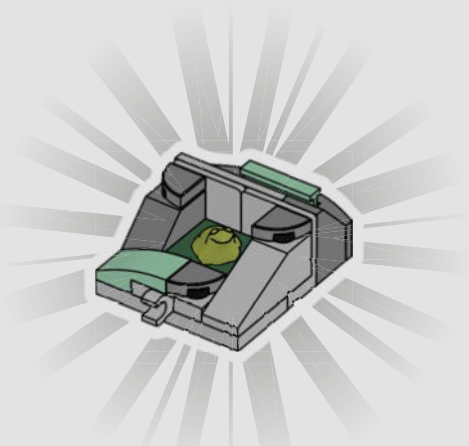



86

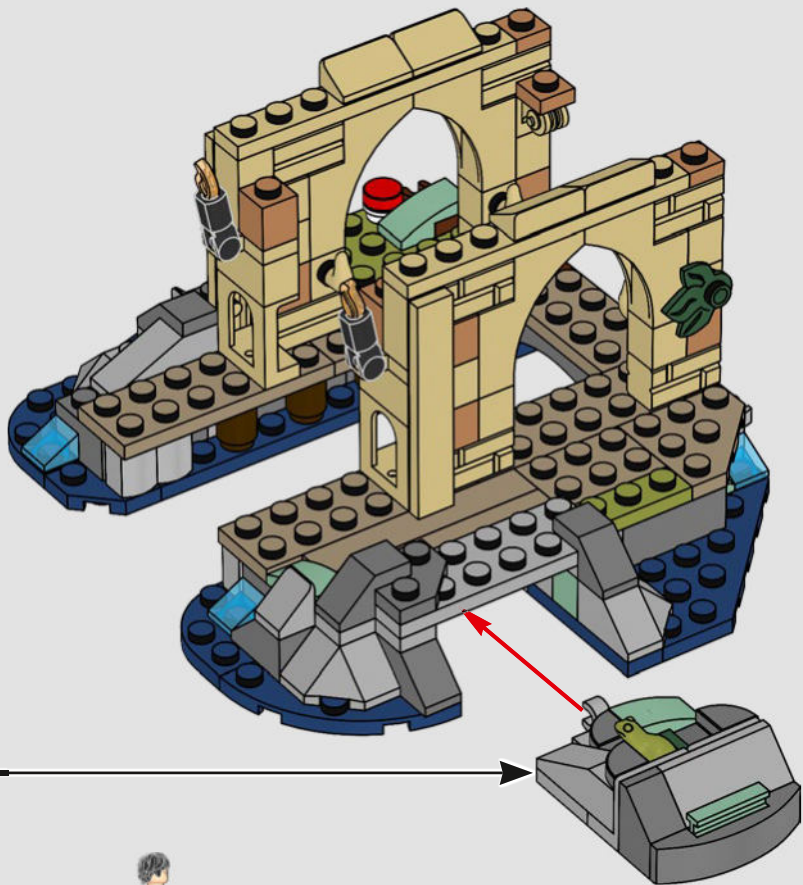
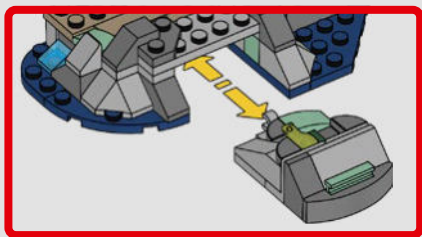



87

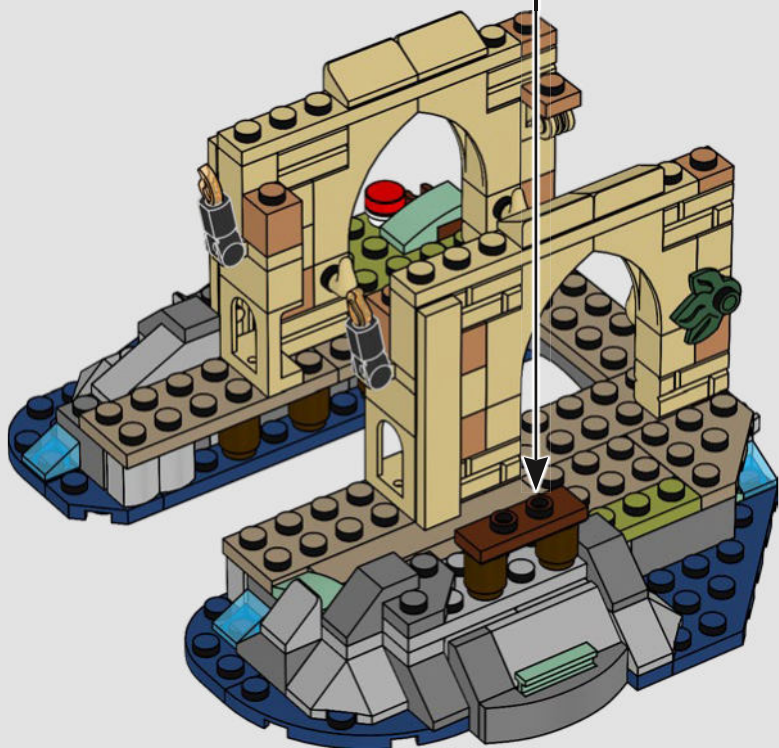
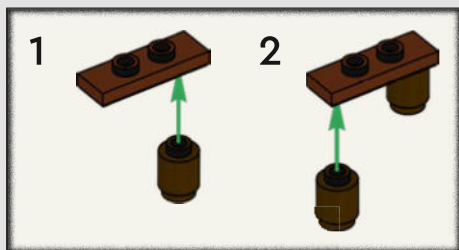

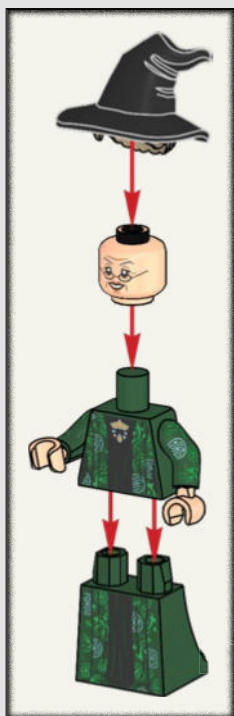

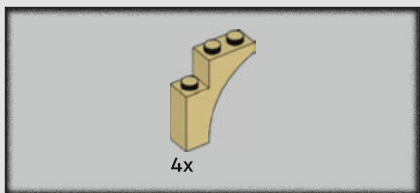

88

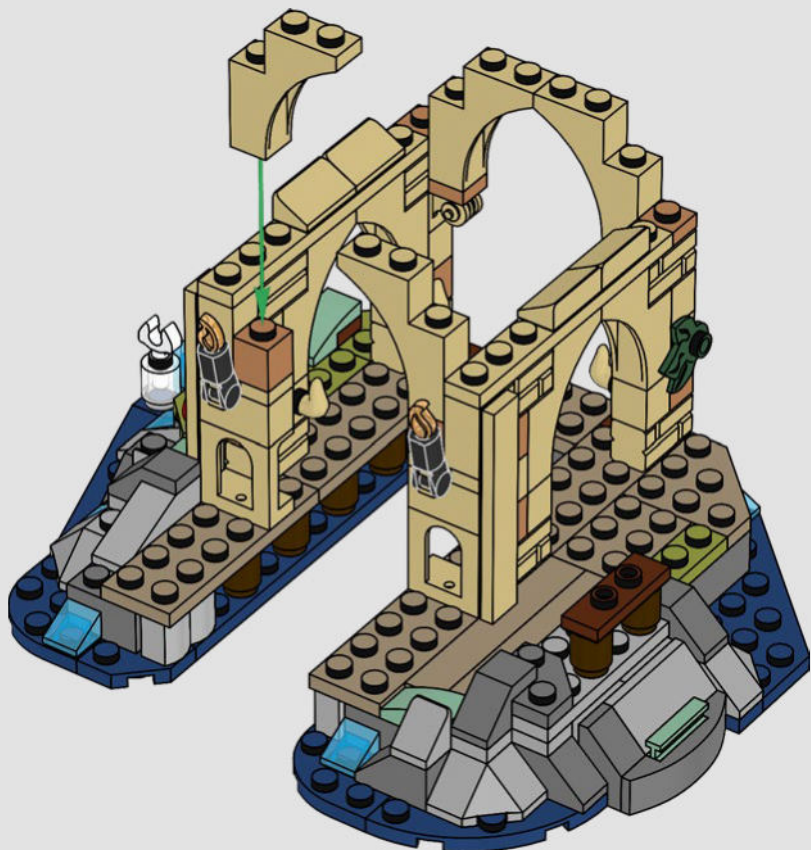



89

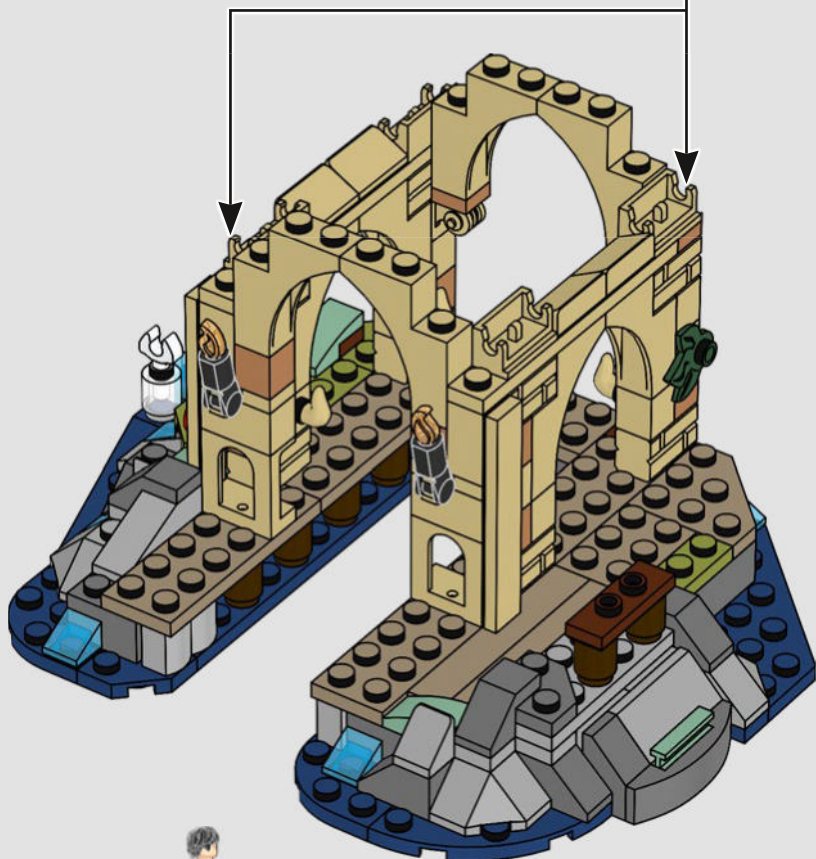



2x

90

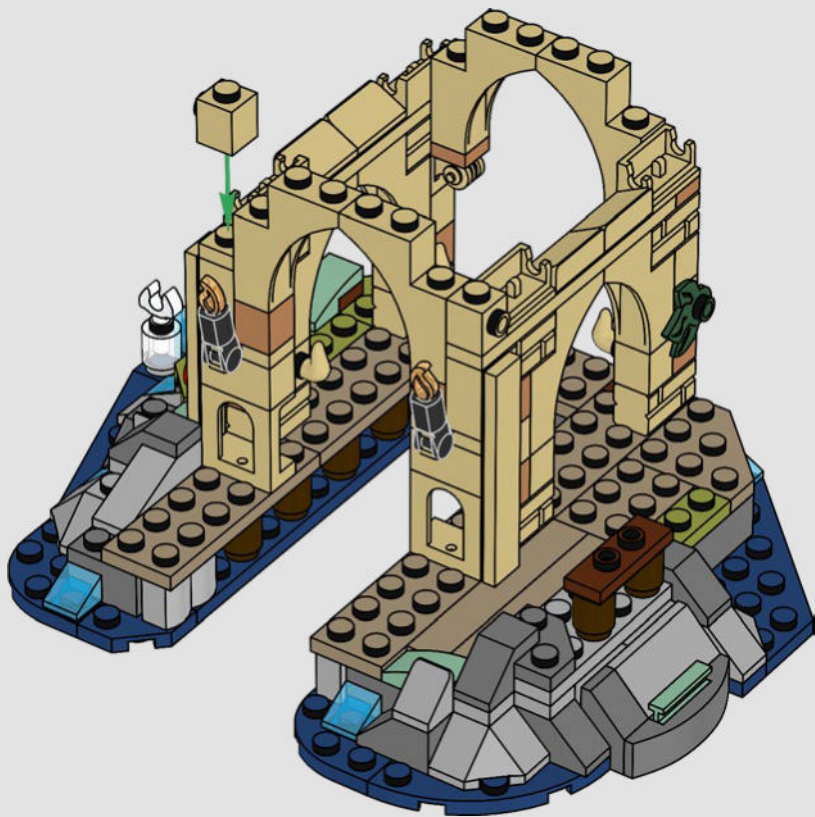

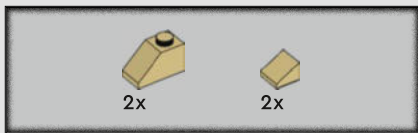

91

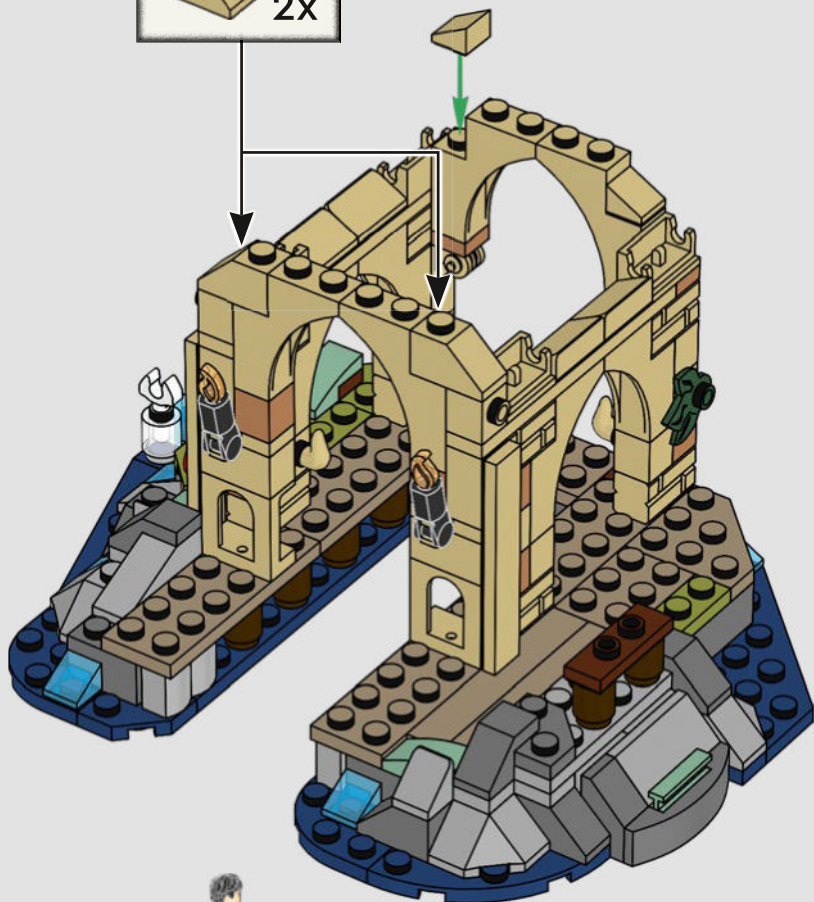

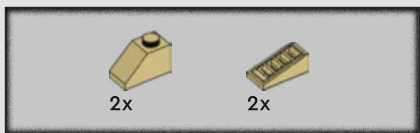

92

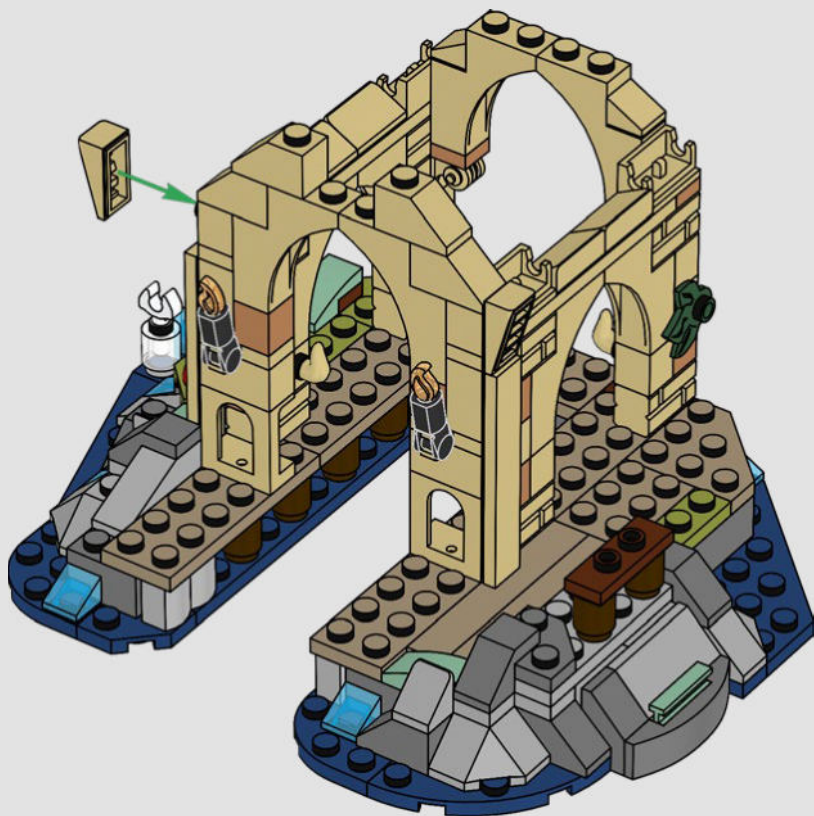



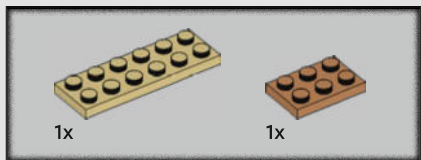

93

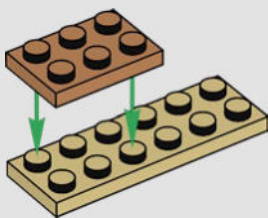

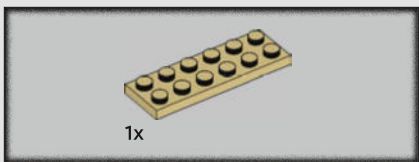

94

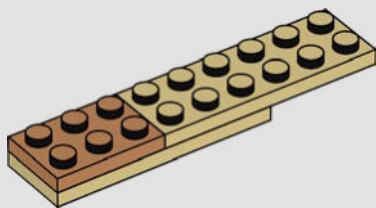



95

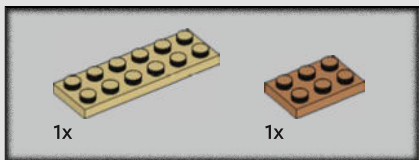
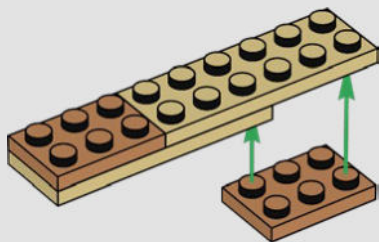

96

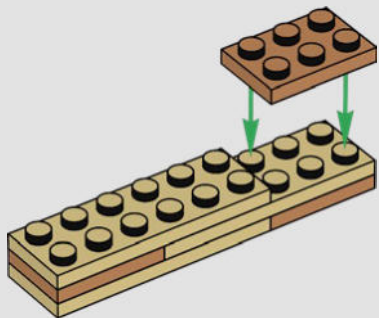

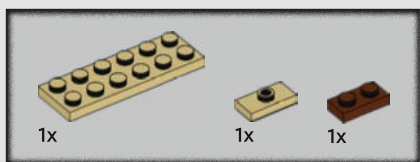

97

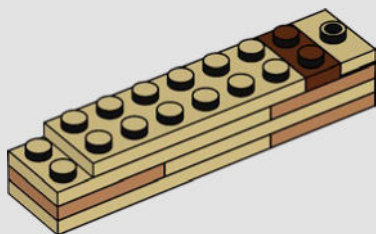

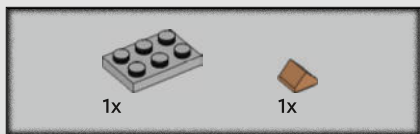

98

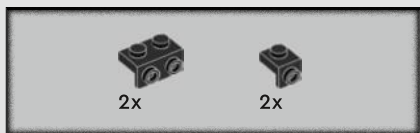
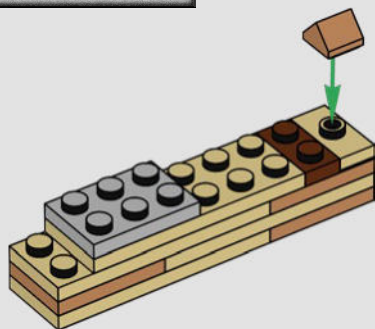

99

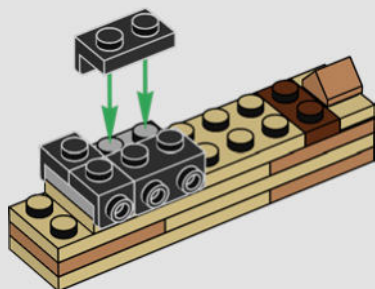



100

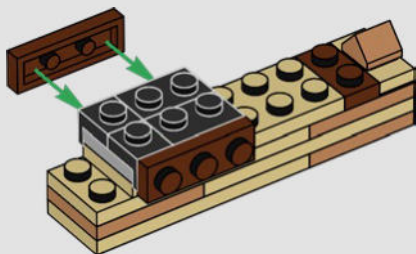

101

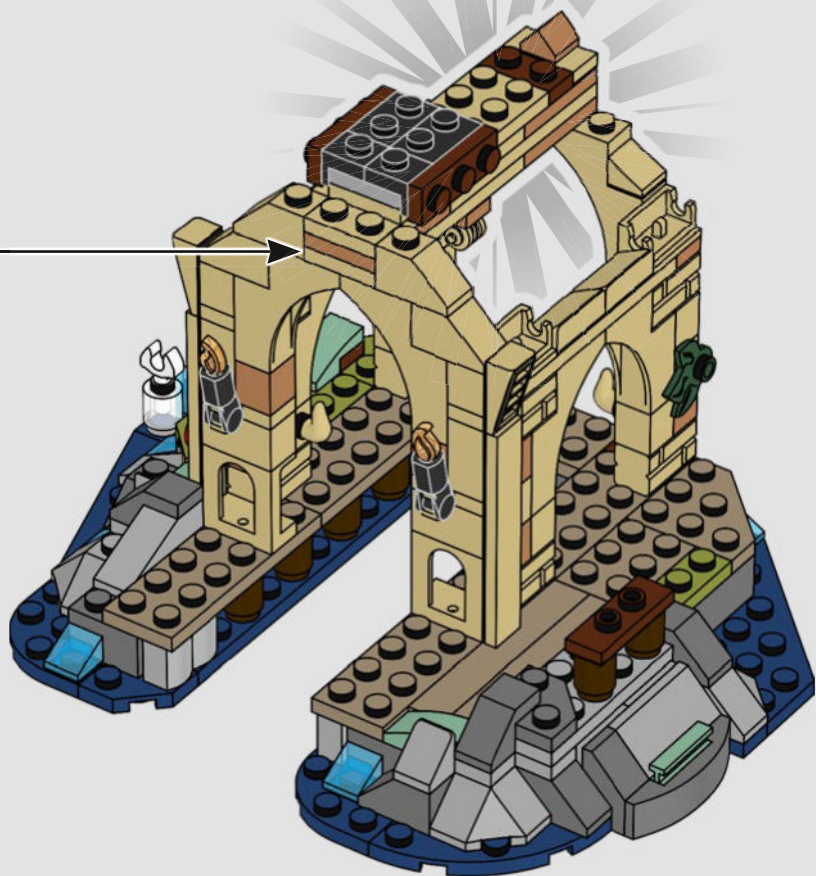



2x

102

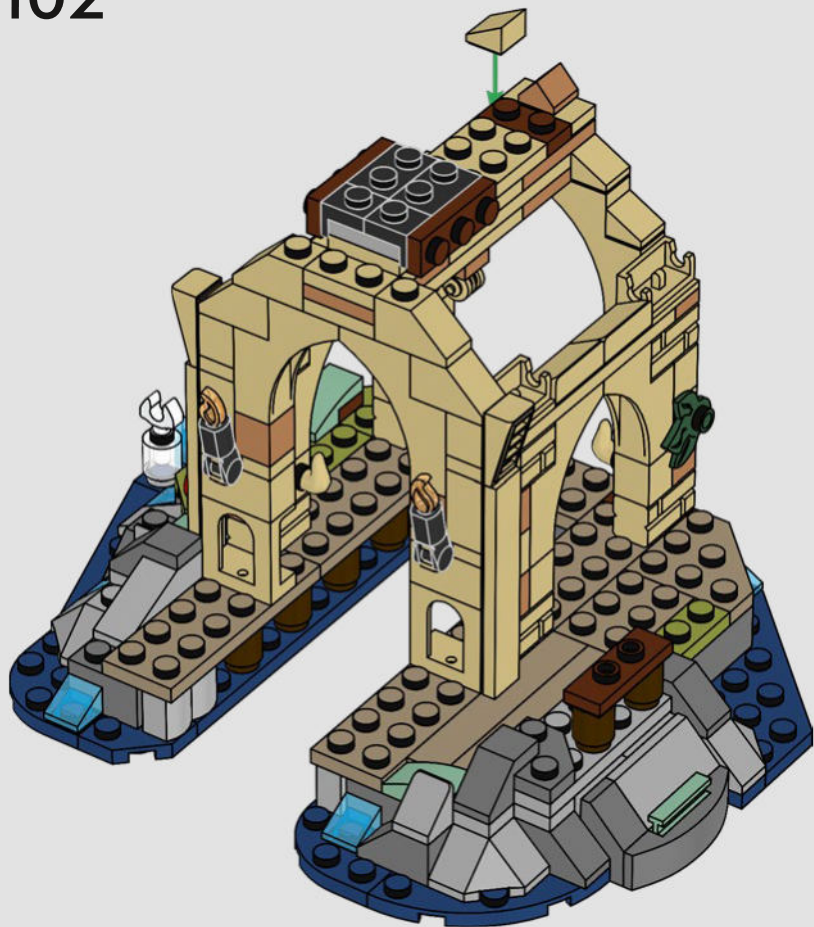



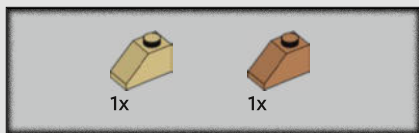

# 103

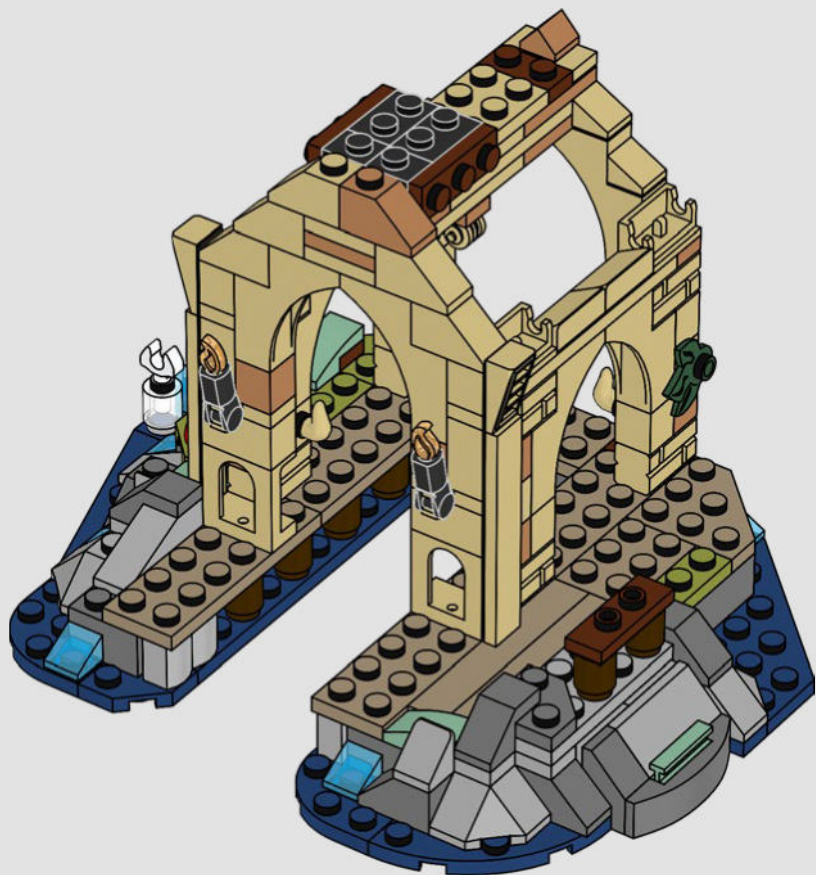

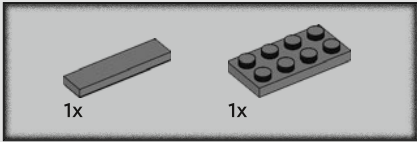

104

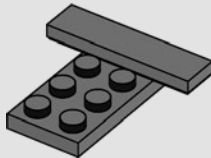

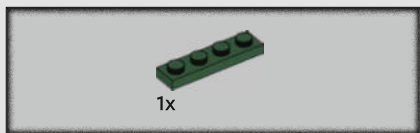

# 105

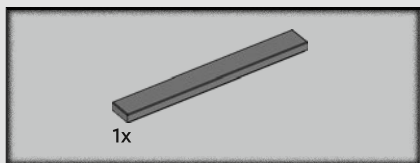
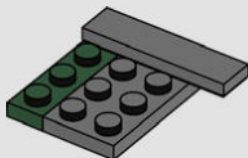

# 106

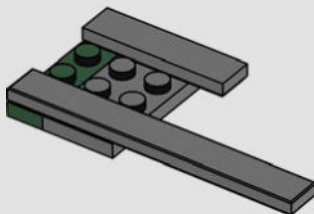

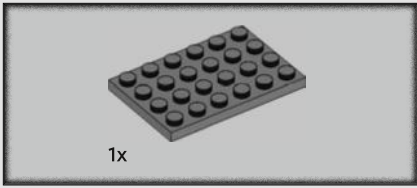

107

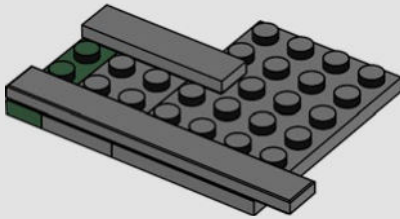

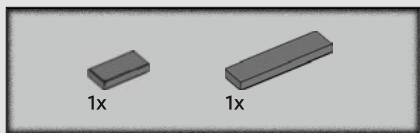

# 108

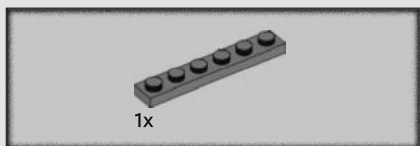
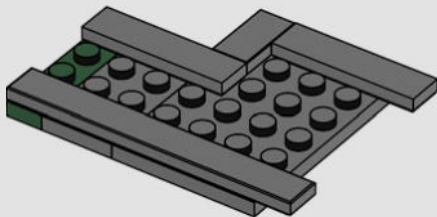

# 109

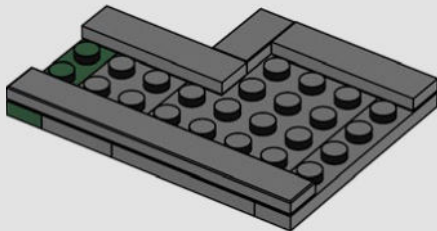



# 110

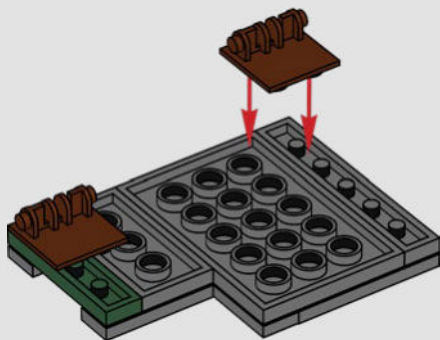

# 111

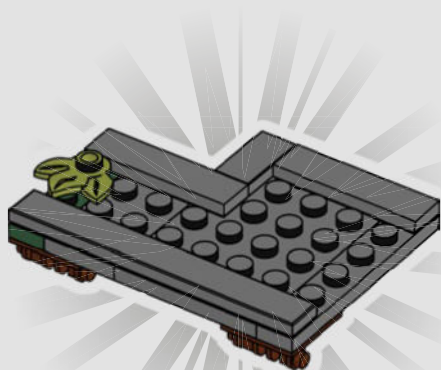

112

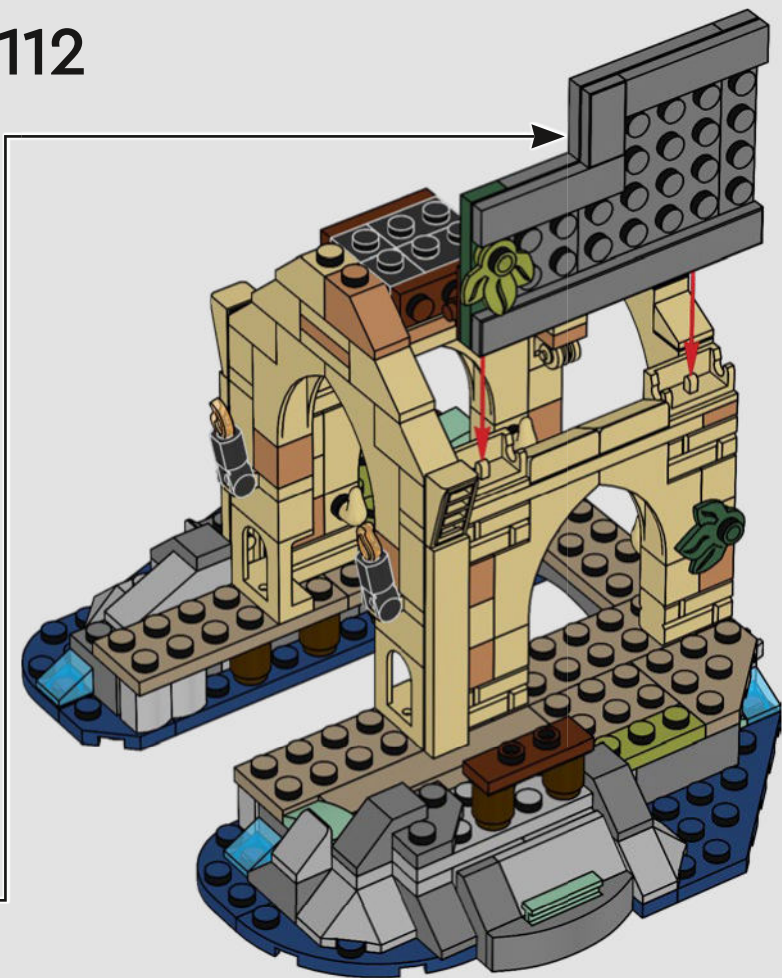

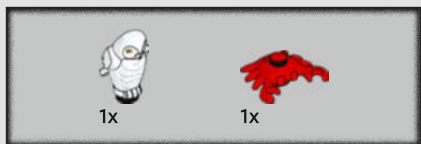

113

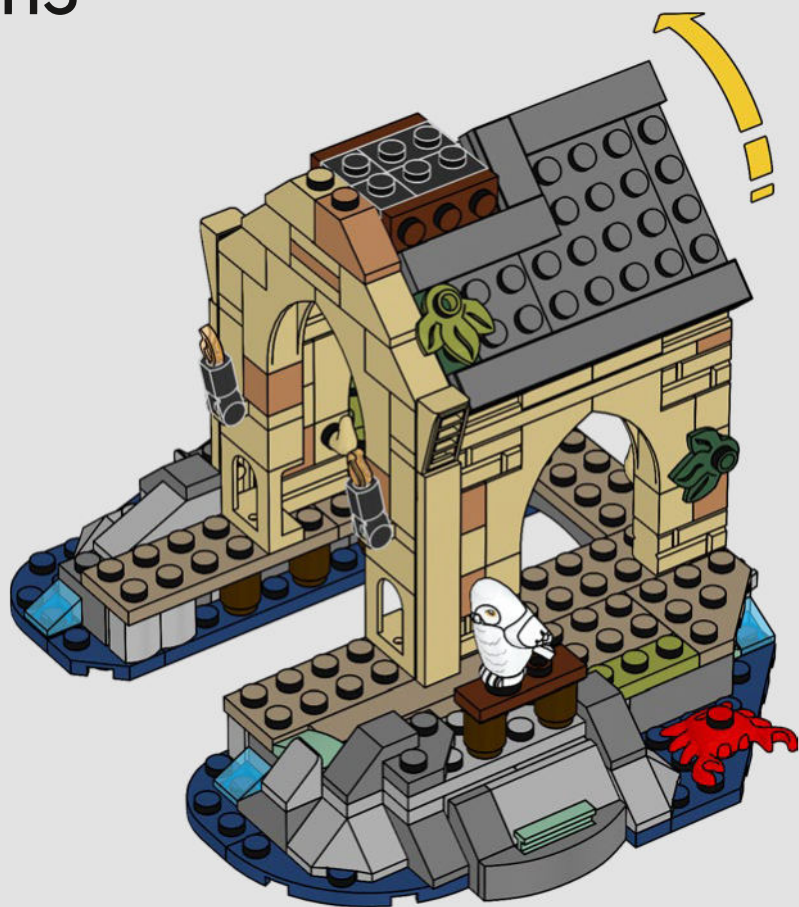



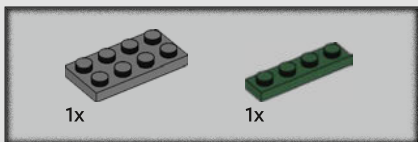

# 114

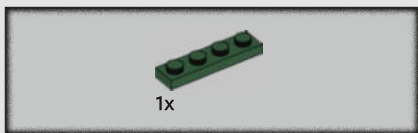
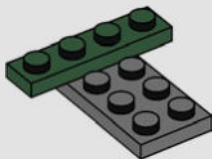

# 115

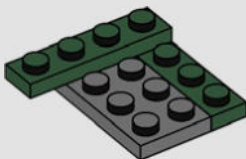

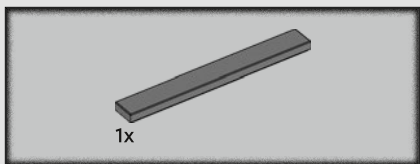

116

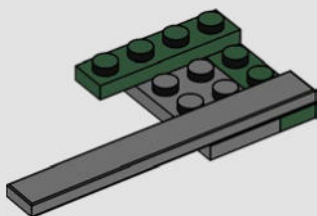

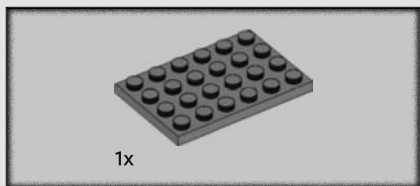

117

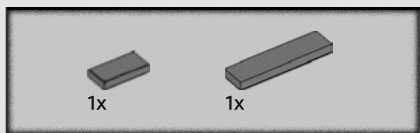
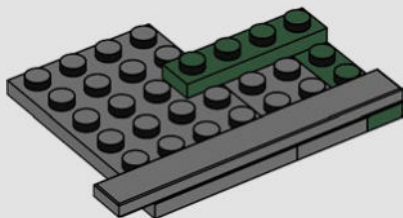

118

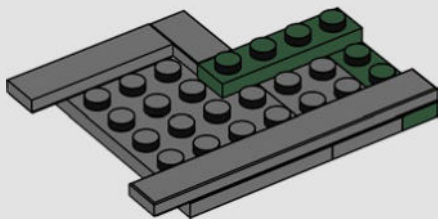

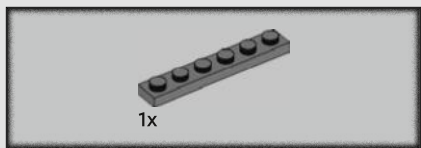

119

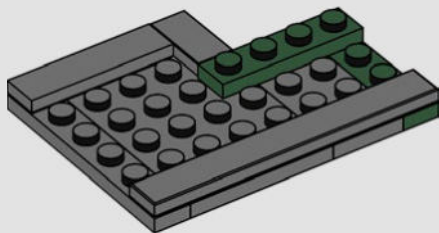



# 120

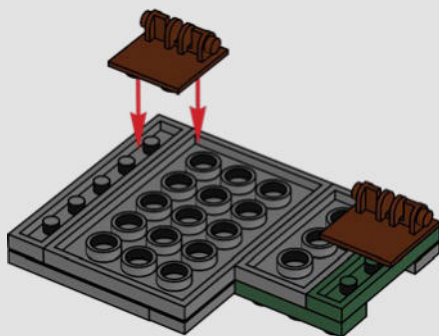

# 121

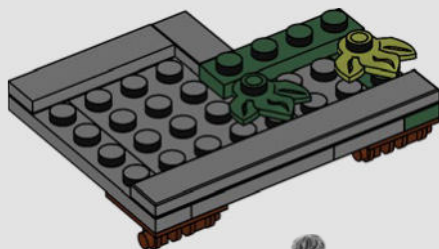



1x

# 122

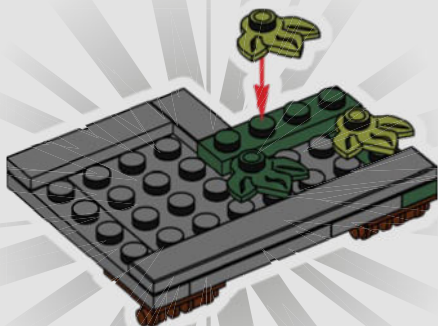

123

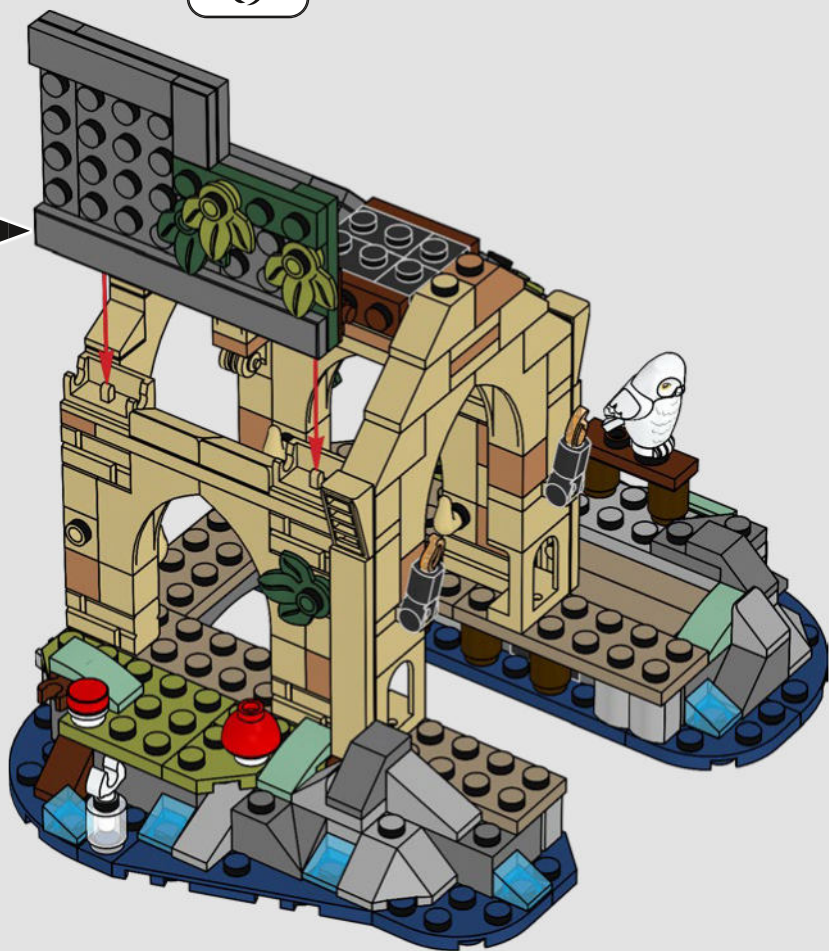



1x

124

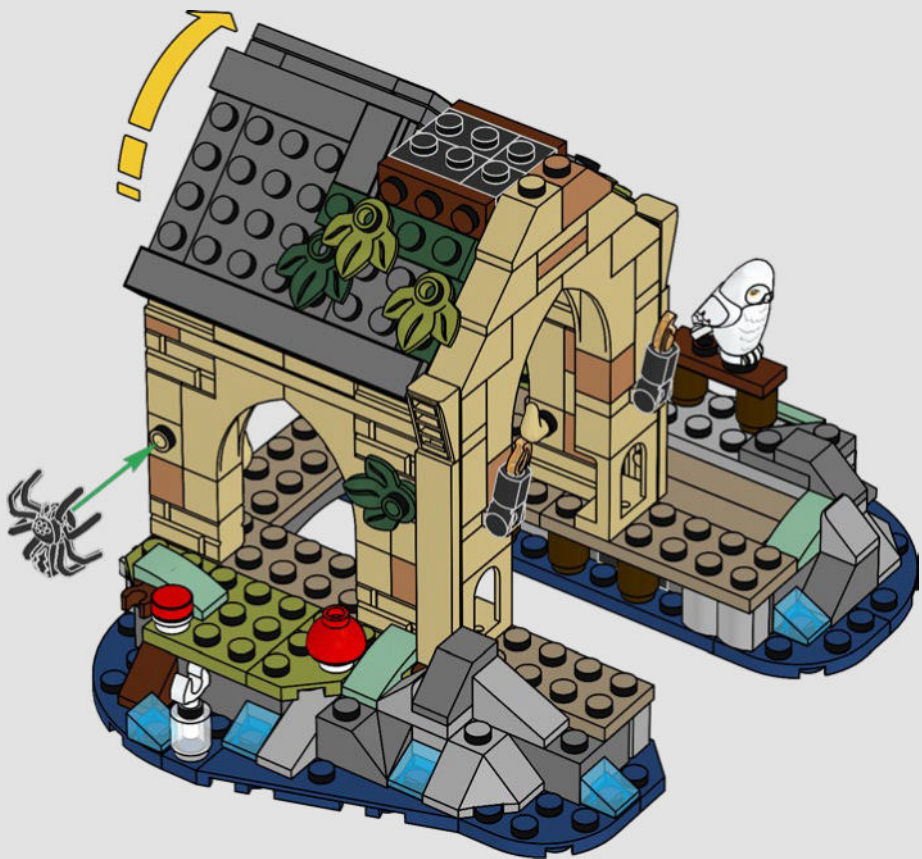





125

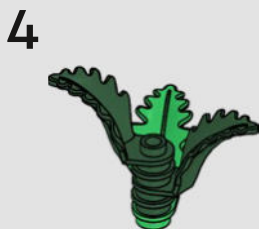
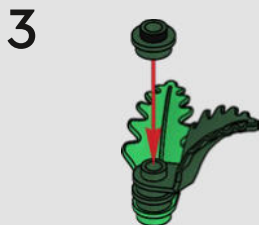
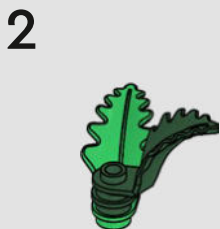
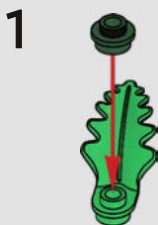

5

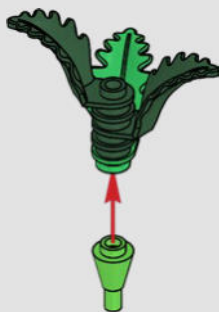

6

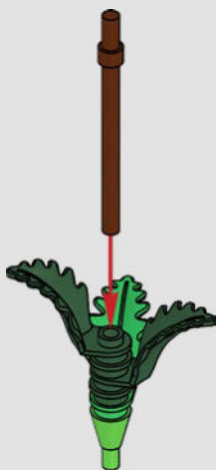

7







1x

# 126

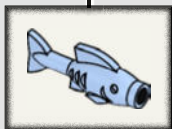

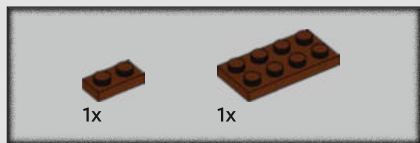
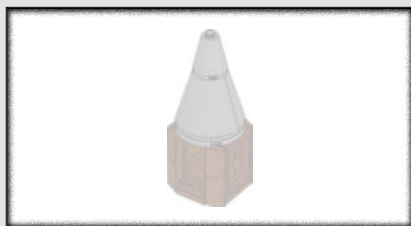

127

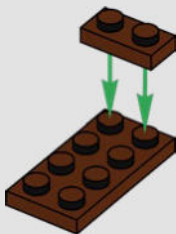

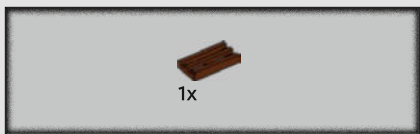

128

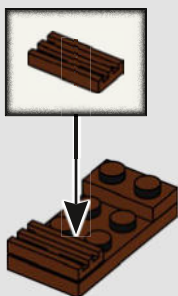



# 129

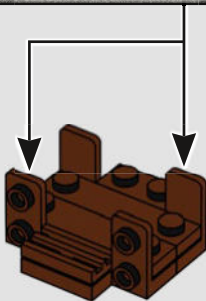
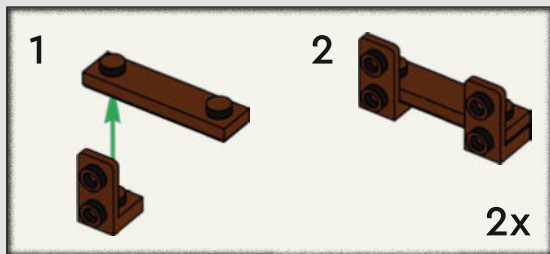



130

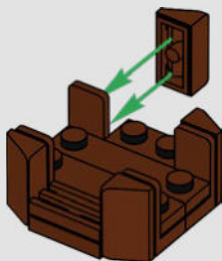



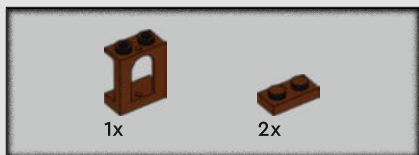

131

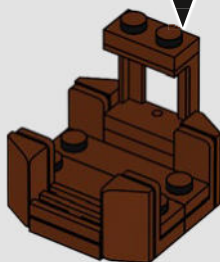
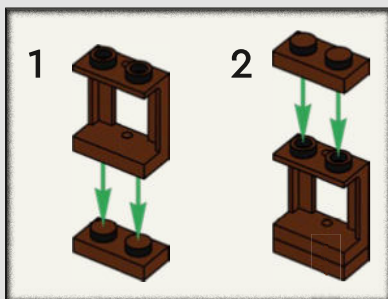

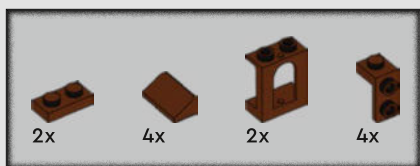

132

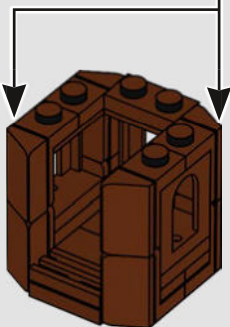
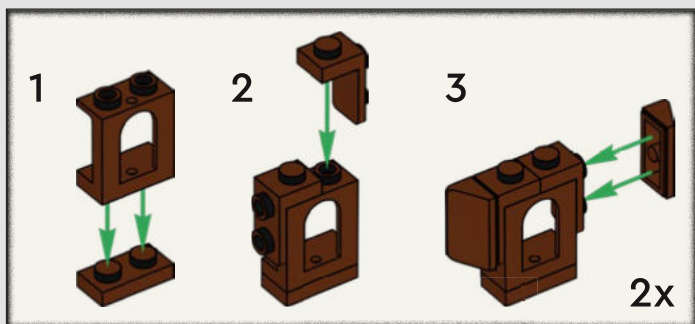

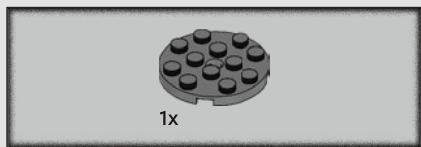

133

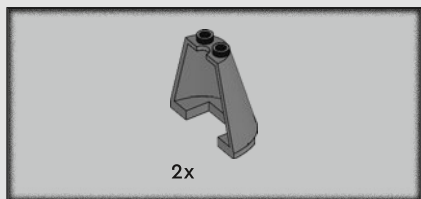
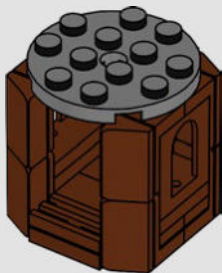

134

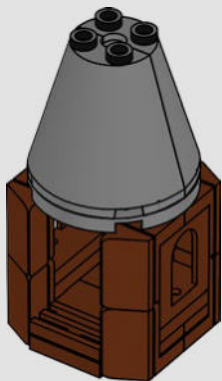

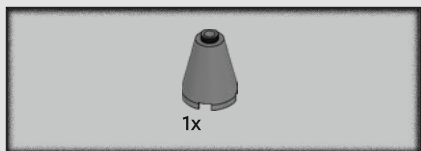

135

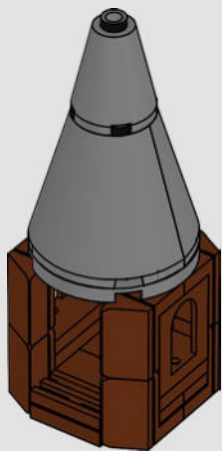

136





# 137

1



2



3

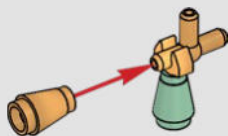

4

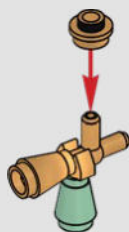







138





# 139

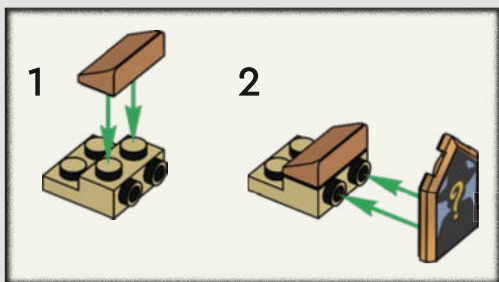





# Harry Potter



## Build the most detailed HOGWARTS™ CASTLE



Baue das detaillierte Schloss Hogwarts™ / Construisez le château de Poudlard le plus détaillé / Costruisci il Castello di Hogwarts™  
più dettagliato di sempre / Construye el Castillo de Hogwarts™ más detallado / Construa o mais detalhado Castelo de Hogwarts™ /  
拼搭精美的霍格沃茨™城堡 / Zbuduj najbardziej szczegółowy zamek Hogwart™ / Postavte si ten najdetailnejši Bradavický hrad /  
Postavte si najdetailnejši Rokfortský hrad / Építsd meg a legrészletgazdagabb Roxfort™ kastélyt! / Construieste cel mai detaliat Castel  
Hogwarts™ / Постройте най-детальнату версію на замька Хогвортс / Uzbuve visdetalizetako Cükkrápas pili / Pane kokku  
kõige üksikasjalikum Sigatüüka™ loss / Sukonstruokite nepaprastai detalią Hogwartso pili

Each set sold separately and available for different periods of time / Jedes Set ist separat und in unterschiedlichen Zeiträumen erhältlich.  
/ Chaque set est vendu séparément et sera disponible à des périodes différentes. / Ogni set è venduto separatamente ed è disponibile per  
periodi di tempo diversi. / Cada set se vende por separado y está disponible durante un cierto período de tiempo. / Os sets são vendidos  
separadamente e estão disponíveis por diferentes períodos de tempo. / 每款套装于不同时间段单独出售。 / Zestawy są sprzedawane  
osobno i są dostępne w różnym czasie / Každá stavebnice se prodává samostatně a je k dispozici v různých časových obdobích / Každá  
stavebnica sa predáva samostatne a je k dispozícii v rôznych časových obdobiach / Minden egyes készlet külön-külön és más-más időszakra  
kapható. / Seturile se vând separat și sunt disponibile pentru perioade diferite de timp / Всеки комплект се продава отделно и с наличен  
за различен период от време. / Katrs komplekts tiek pārdots atsevišķi, un to pieejamības periodi atšķiras. / Koik komplektid on müügil  
eraldi ja saadaval erinevates ajavahemikes. / Kiekvienas rinkinys parduodamas atskirai ir tik ribotą laiką

# Collect all 14 Portraits

Portrait tiles are packed randomly  
in the sets.

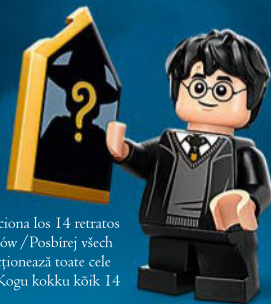
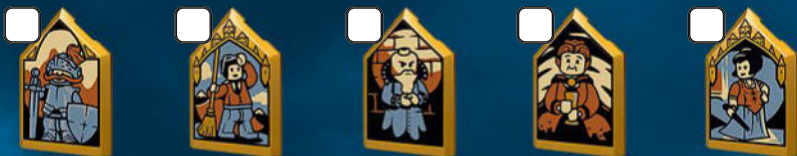

Samle alle 14 Porträts / Collectionnez les 14 portraits / Collezione i 14 ritratti / Colecciona los 14 retratos / Coleccione todos os 14 retratos / 集齐所有 14 种肖像 / Zbierz wszystkie 14 portretów / Posbírej všech 14 portrétů / Nazbieraj všetkých 14 portrétov / Gyűjtsd össze mind a 14 portrét! / Colectionează toate cele 14 portrete / Съберете всички 14 портрета в колекция / Sakrāj visus 14 portretus / Kogu kokku kõik 14 portreed / Surinkite visus 14 portretų

Die Porträt-Steinchen werden nach dem Zufallsprinzip in die Sets gepackt. / Les tuiles avec des portraits sont réparties de manière aléatoire dans les sets. / Le tessere dei ritratti sono inserite in maniera casuale in ogni set. / Las cubiertas con retratos se incluyen en los sets de forma aleatoria. / As peças dos retratos estão distribuídas aleatoriamente nos sets. / 肖像光板随机附于套装中。 / W zestawach znajdują się losowe płytki do portretów. / Dílky s portréty jsou do stavebnic balené náhodně. / A portrét véletlenszerűen kerülnek a csomagba. / Pláčuțele cu portrete sunt incluse aleatoriu în seturi. / Плочките с портрети са включени в комплектите на случаен принцип. / Portretu elementi komplektiem tiek pievienoti pēc nejaušības principa. / Portree detalid pakitakse komplektidesse juhuslikult. / Rinkiniuose esančios portretų plytelės parinktos atsitiktinai.





1x  
6092666



2x  
4211052



2x  
6235153



7x  
4211105



3x  
4211053



1x  
4648256



3x  
6168776



3x  
6199549



4x  
4211135



1x  
6164073



2x  
4211088



1x  
6477380



2x  
4211065



1x  
4528323

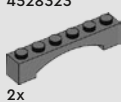

2x  
4620760



2x  
4211056



2x  
4211115

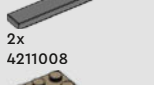

2x  
4211008



1x  
6035540



1x  
4267874



1x  
6038637



1x  
6270031



2x  
4507047

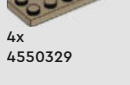

4x  
4550329



1x  
6415048



1x  
6234806



3x  
6342981

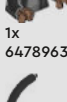

1x  
6478963



2x  
6156414



1x  
6356861



1x  
6233922



2x  
474026



3x  
4596914



1x  
6378773



1x  
6266207



2x  
6016172



1x  
6359881



2x  
6321194



2x  
4529236

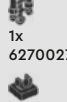

1x  
6270027



2x  
6335388



2x  
6299338



2x  
6230571



3x  
6400754



2x  
6447541



1x  
6478294



1x  
6186827



3x  
6020923



1x  
6479492

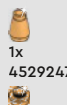

1x  
4529247



1x  
6190252

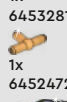

1x  
6453281



1x  
6452472



1x  
6478297



7x  
6057986



1x  
6401014



4x  
6215606



1x  
6218358



1x  
6058135



3x  
6334099



2x  
6357747

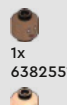

1x  
6382551



1x  
6329308

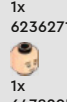

1x  
6236271



1x  
6478295



1x  
6233910



1x  
6253363



1x  
6337734



1x  
6284574



1x  
6411022



1x  
6331087

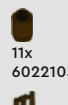

11x  
6022105



2x  
6270032

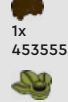

1x  
4535553

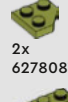

3x  
6398008



2x  
6278087



2x  
6278088



1x  
6472547



1x  
6408049



4x  
6257603



[LEGO.com/service](https://www.LEGO.com/service)

YOU COULD

WIN



Scan this QR code or go to **LEGO.COM/PRODUCTFEEDBACK** and give us your short feedback about this LEGO® set for a chance to win a cool LEGO prize.

Terms and Conditions apply\*

**EN: YOU COULD WIN.** Terms and Conditions apply\* **DE: Du könntest GEWINNEN.** Es gelten die Teilnahmebedingungen\* **FR: Tu pourrais GAGNER.** Des conditions s'appliquent\* **IT: Potresti VINCERE tu.** Termini e condizioni sono applicabili\* **ES: Puedes GANAR.** Aplican términos y condiciones\* **PT: Poderá GANHAR.** Aplicam-se termos e condições\* **ZH: 轻松获奖. 条款和条件适用\*** **PL: Szansa na WYGRANĄ.** Obowiązują warunki korzystania\* **CS: Máte šanci VYHRÁT.** Platí všeobecné smluvní podmínky\* **SK: Máte šancu VYHRAŤ.** Platia všeobecné zmluvné podmienky\* **HU: TE IS NYERHETSZ.** Felhasználási feltételek érvényesek\* **RO: Ai putea CÂȘTIGA.** Se aplică termeni și condiții\* **BG: Можете да СПЕЧЕЛИТЕ.** Има определени правила и условия\* **LV: Tu vari LAIMĒT.** Ir spēkā noteikumi un nosacījumi.\* **ET: Sul on võimalus VÕITA.** Kehtivad tingimused\* **LT: Jūs galite LAIMĖTI.** Taikomos sąlygos\*

\*[LEGO.com/productfeedback-terms](https://www.lego.com/productfeedback-terms)

LEGO and the LEGO logo are trademarks of the LEGO Group. ©2024 The LEGO Group.  
WIZARDING WORLD and all related trademarks, characters, names, and indicia are  
© & ™ Warner Bros. Entertainment Inc. Publishing Rights © JKR. (s24)

6507713