

LEGO

Harry Potter™

4701

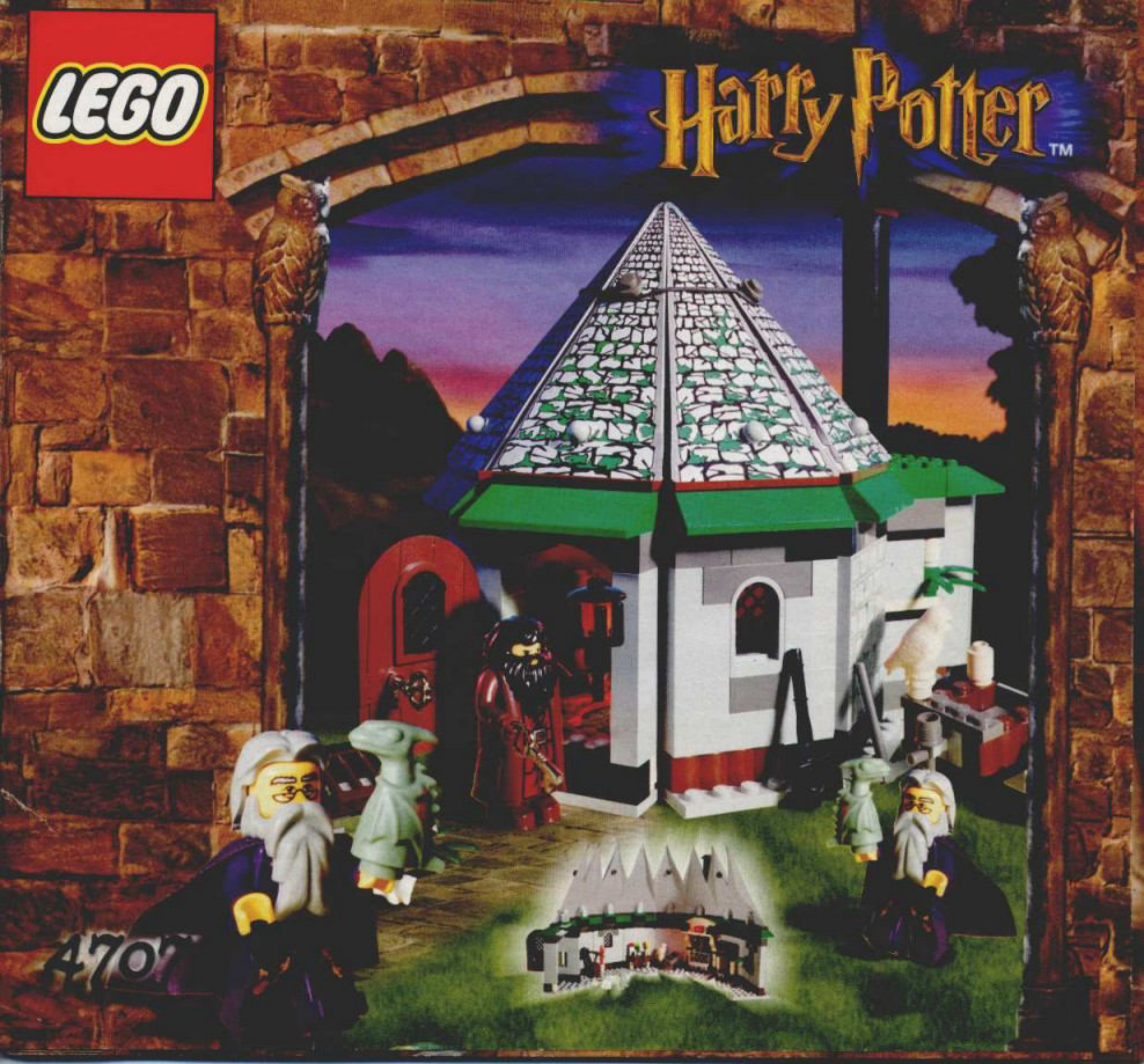

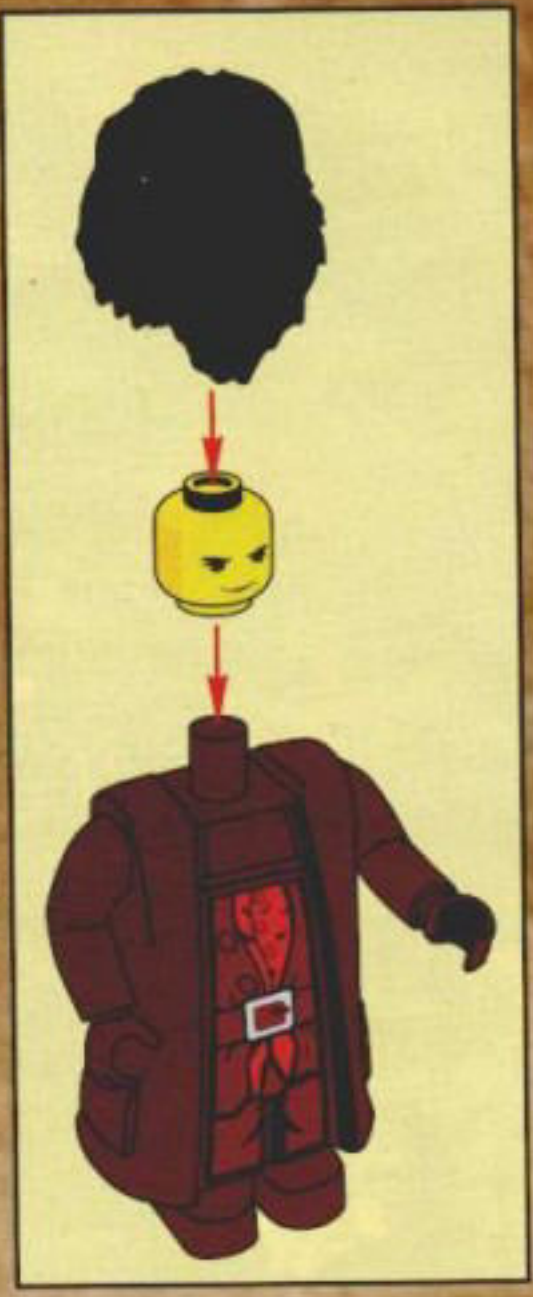

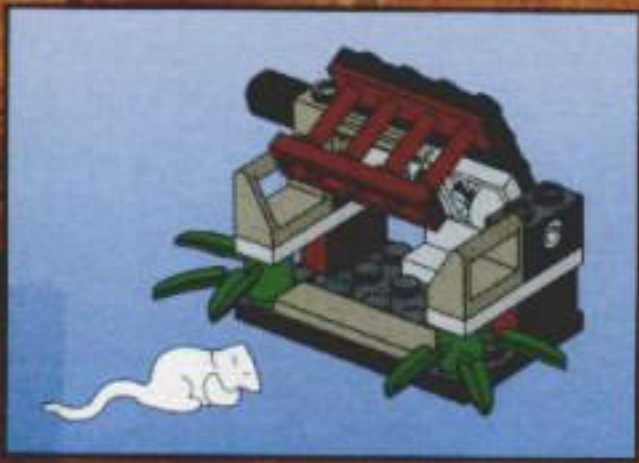

1



2

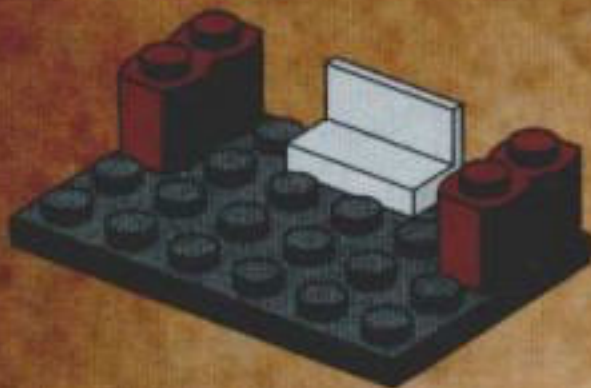

3

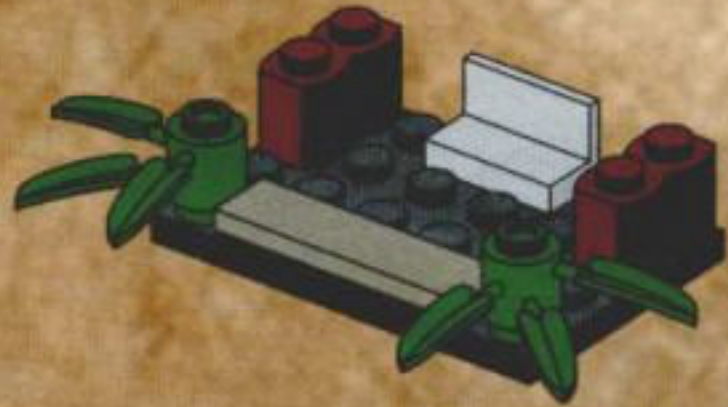

4

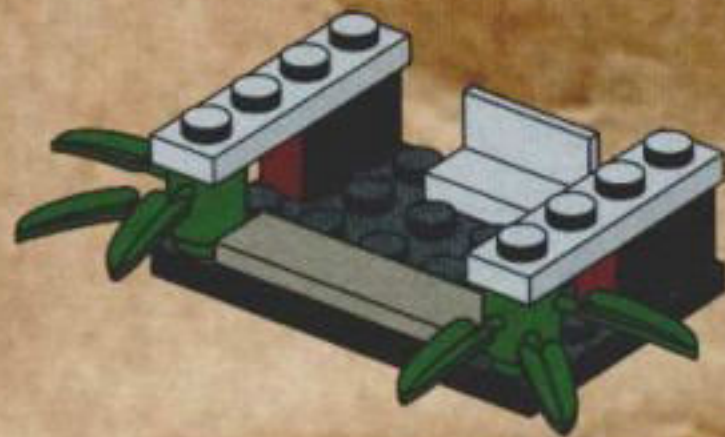

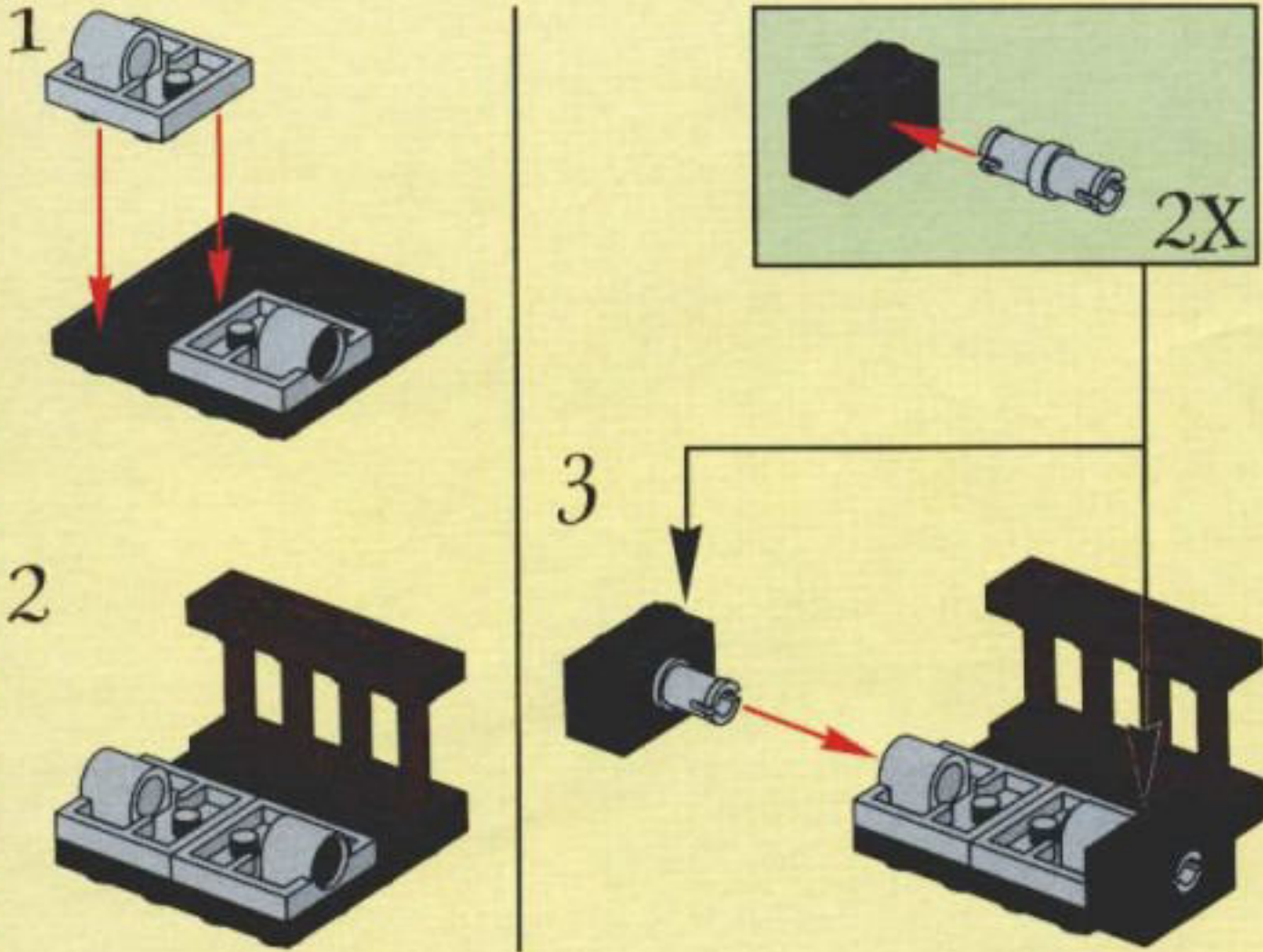

6

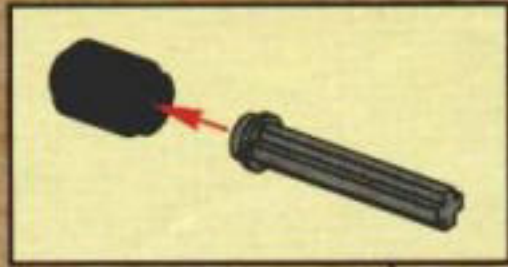
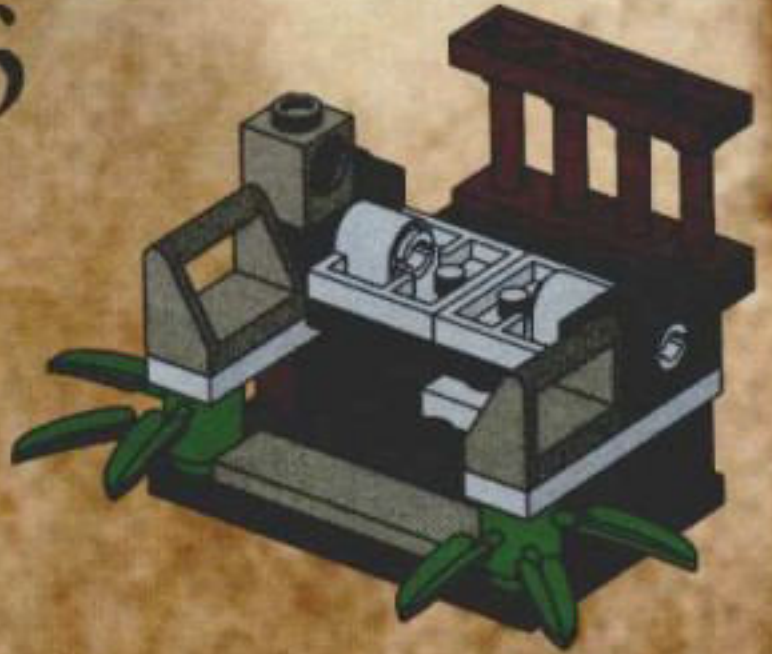

7

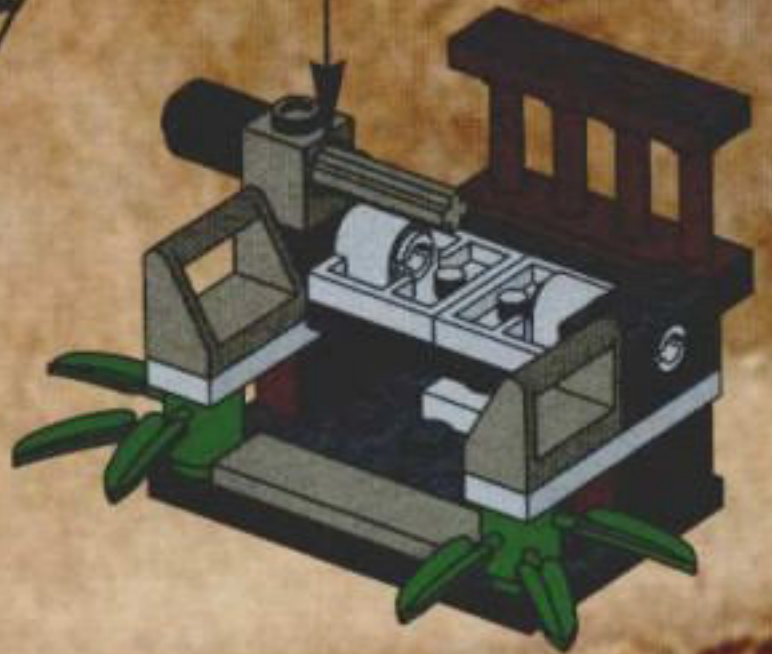

5

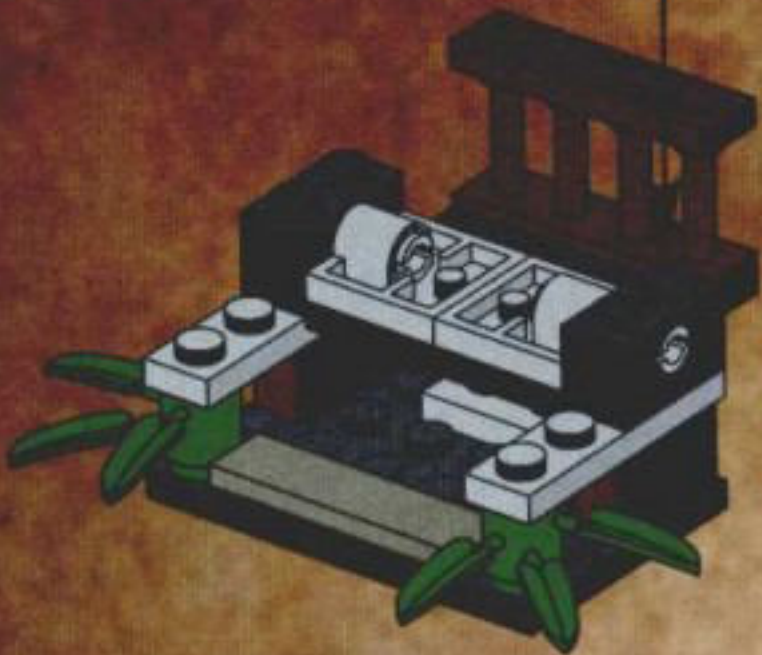

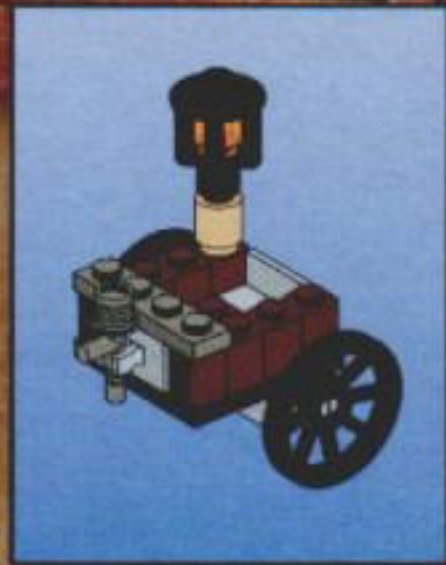

1



2



3



8

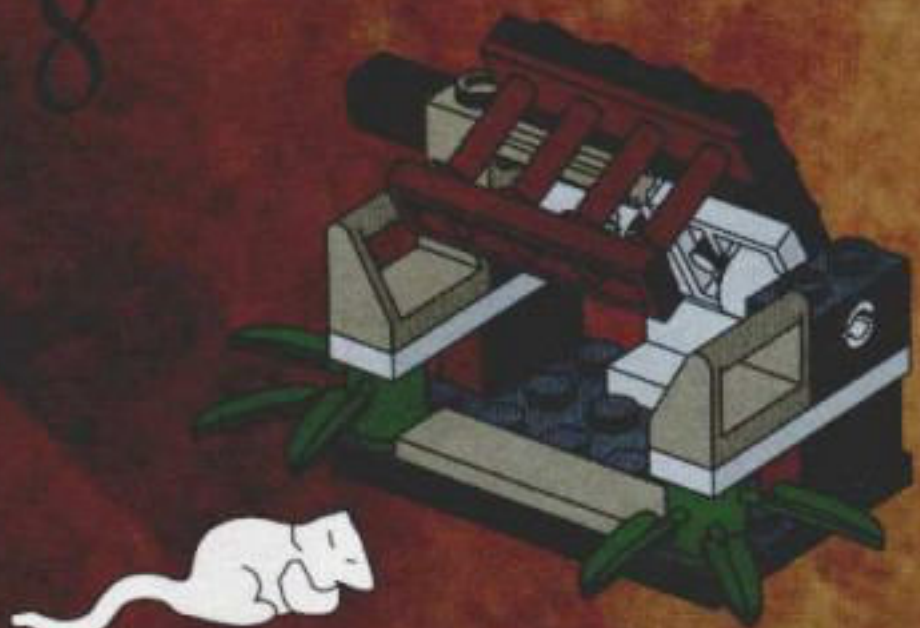

4



5

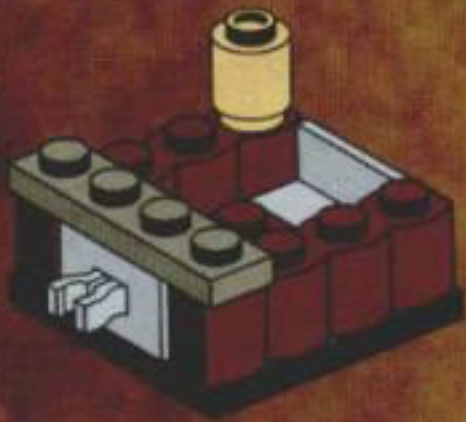

6

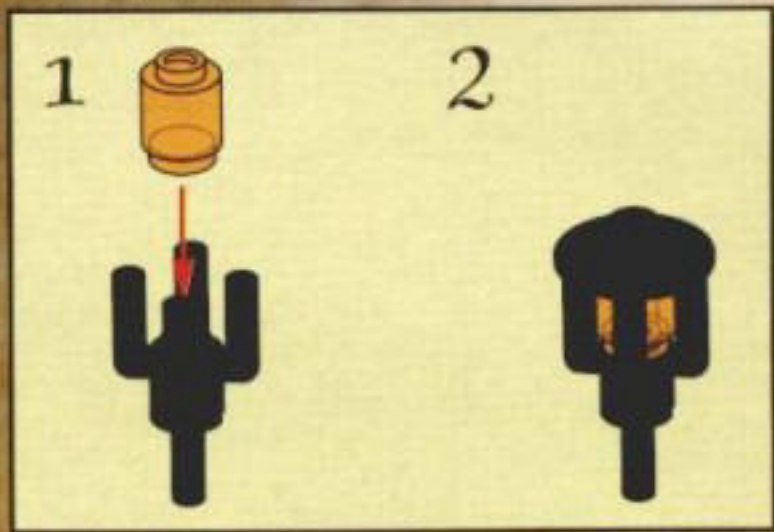
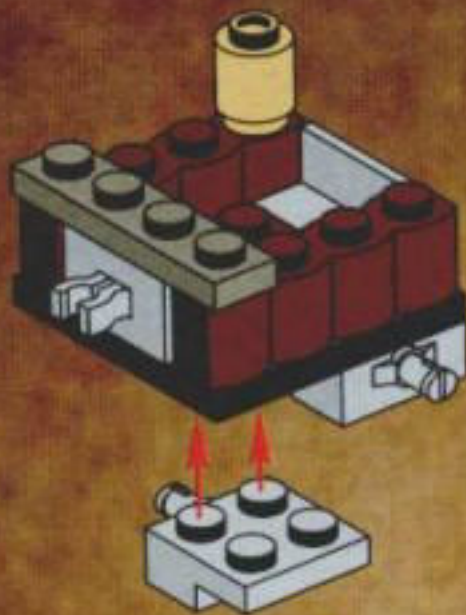

7

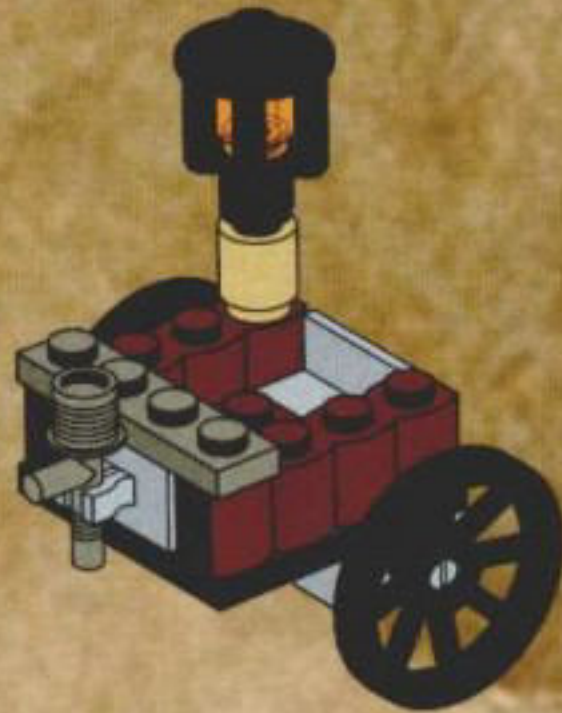

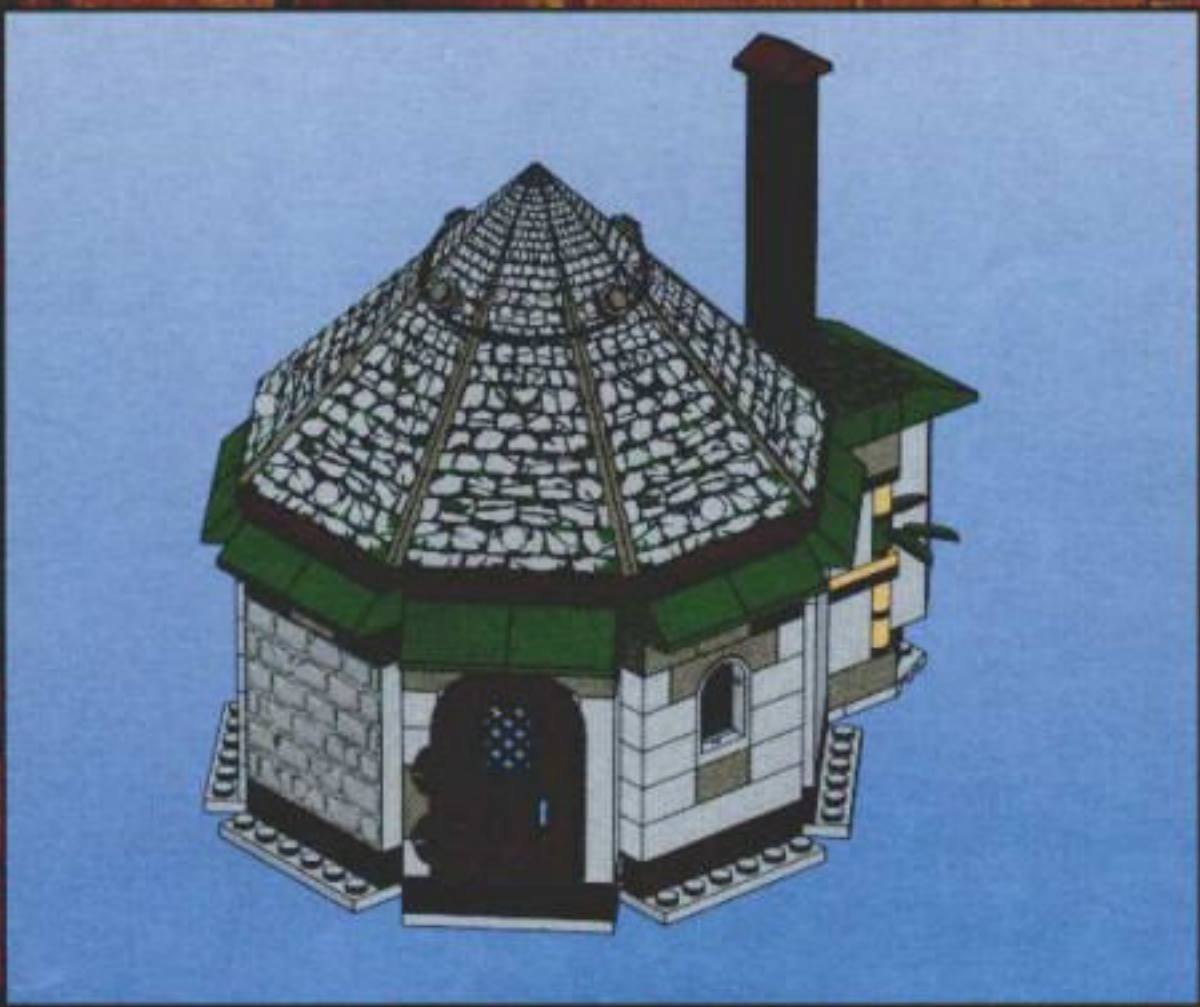

2

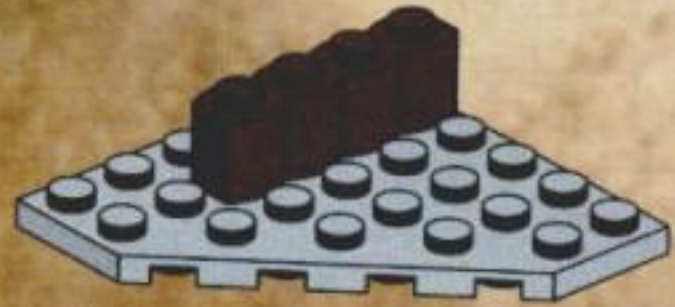

1



3

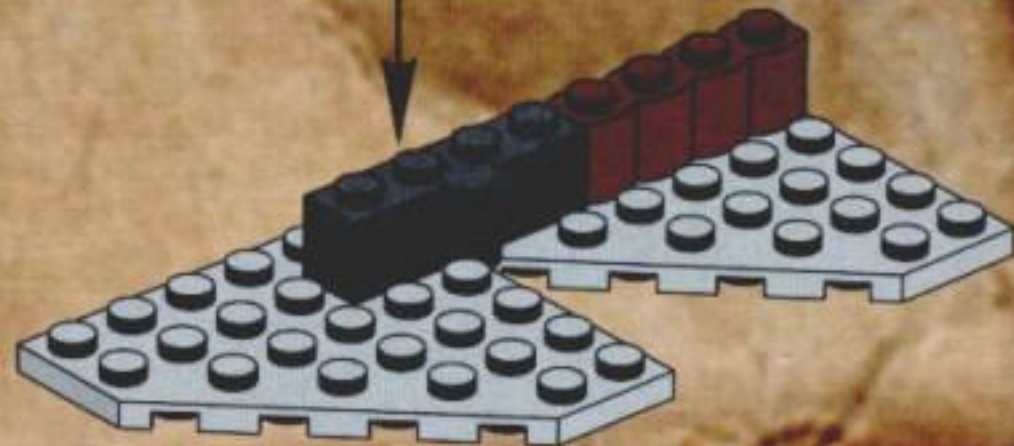
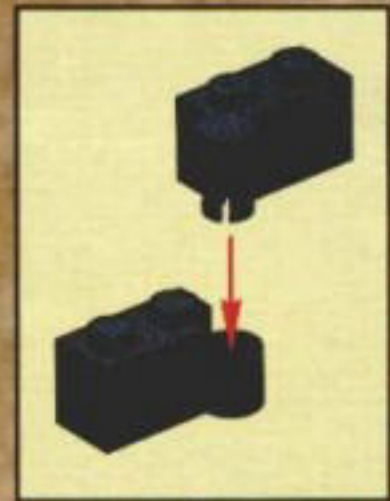

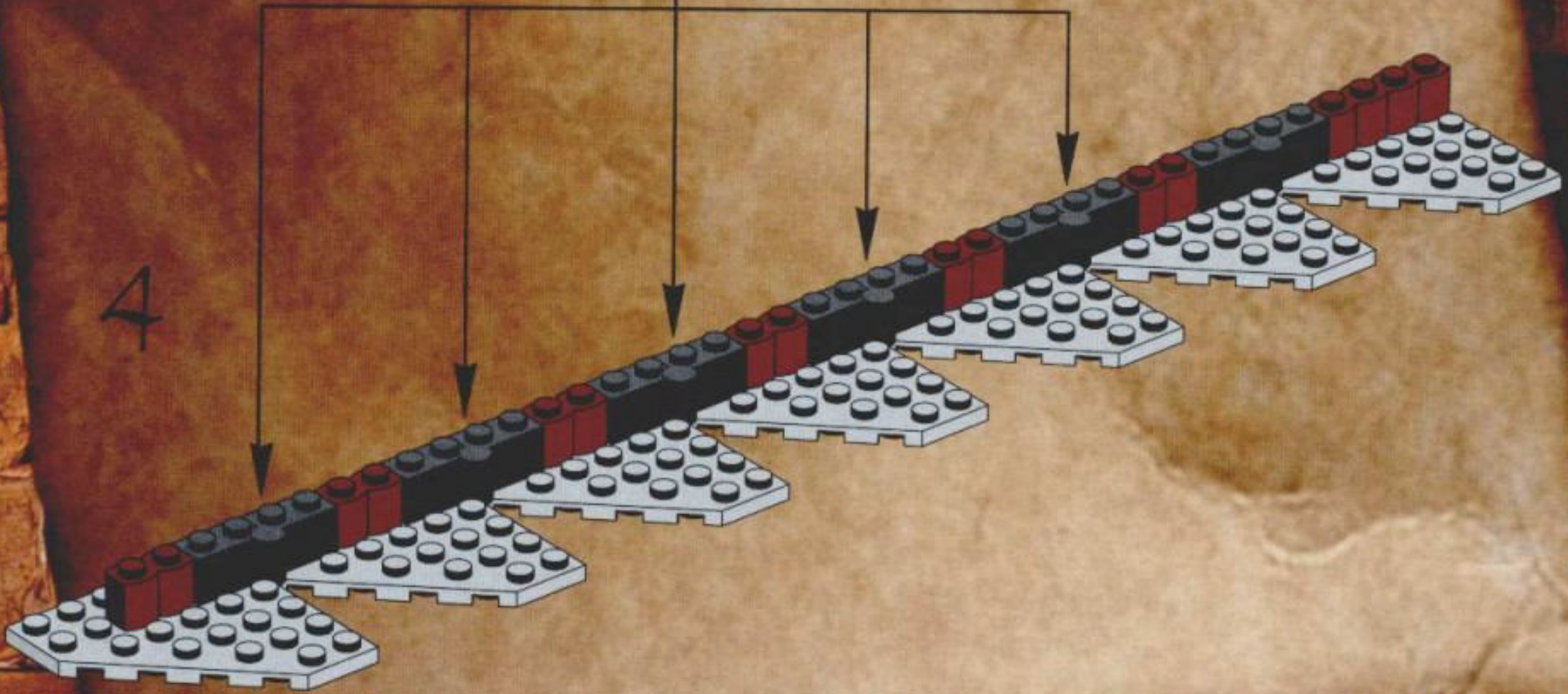
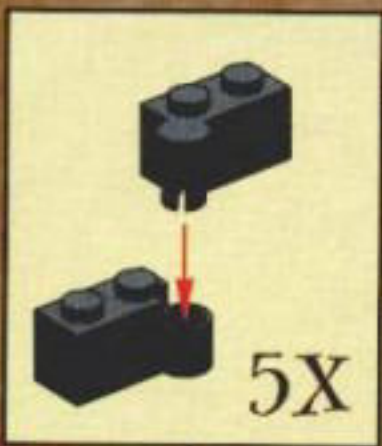

1

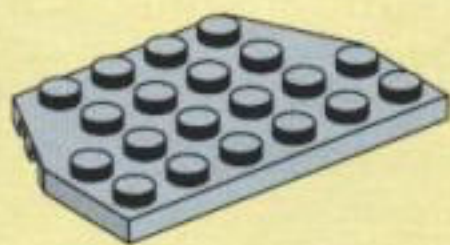

2

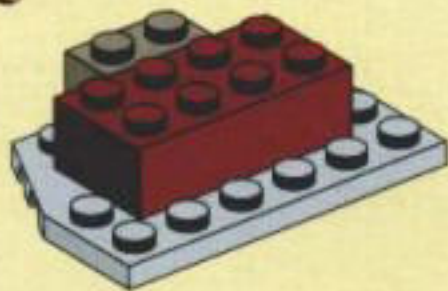

3

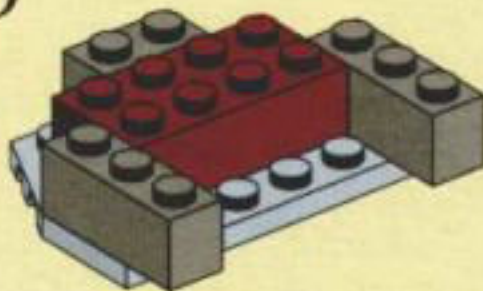

5

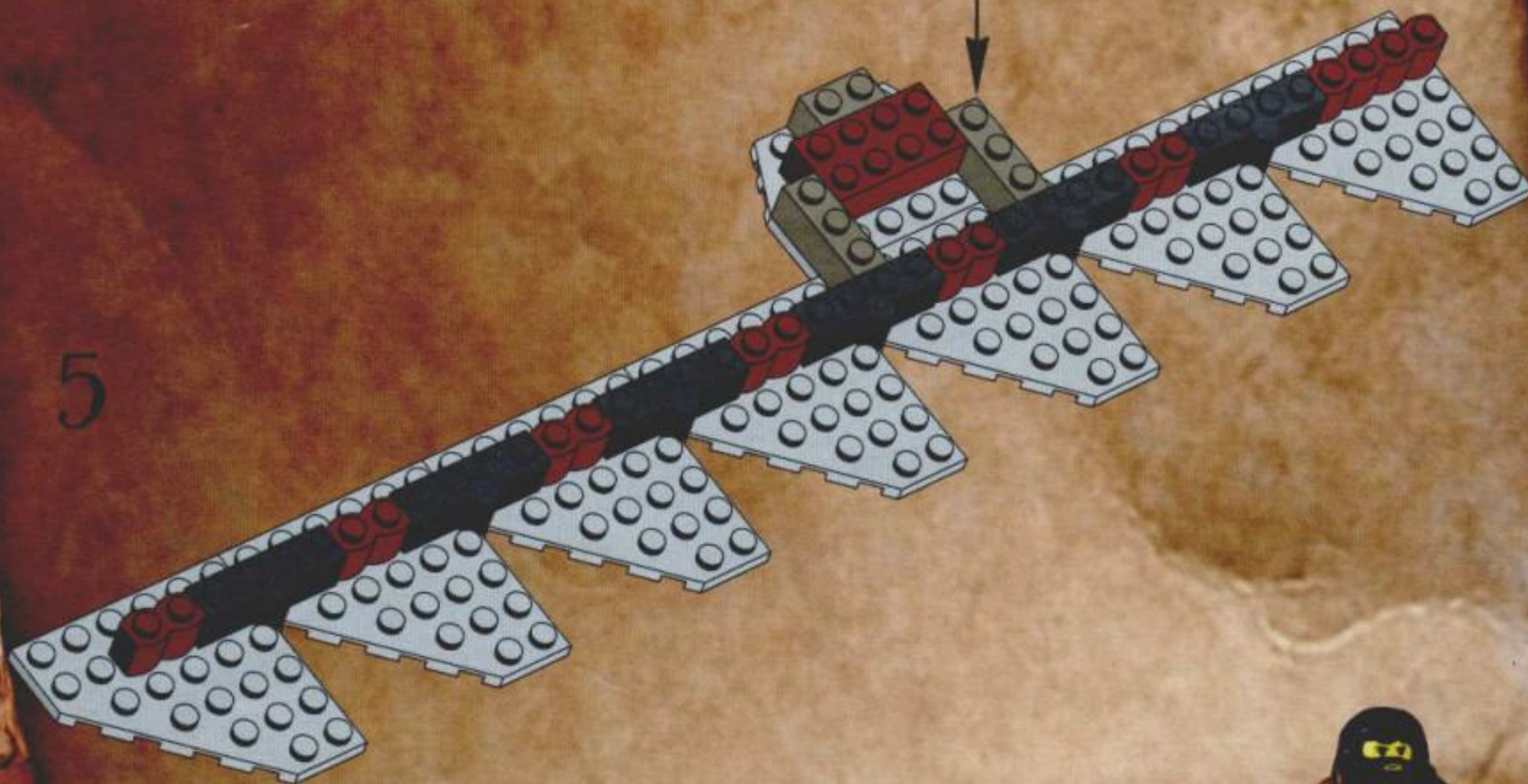

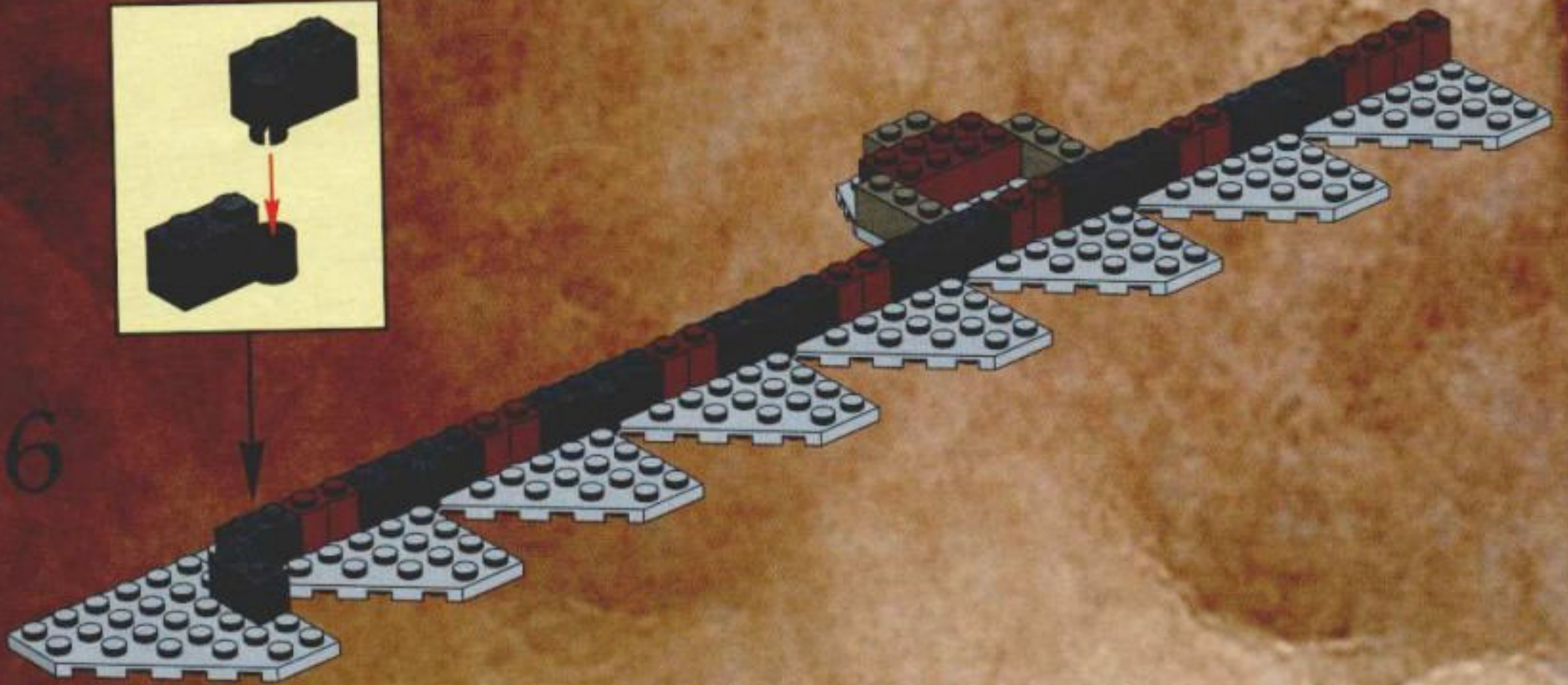
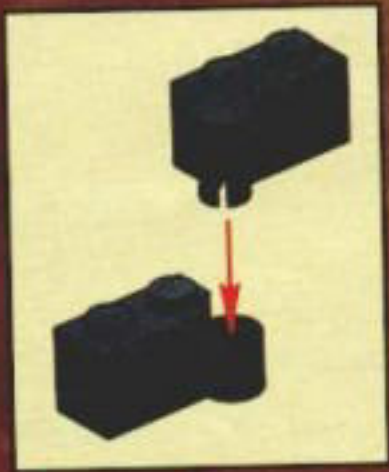

6

10



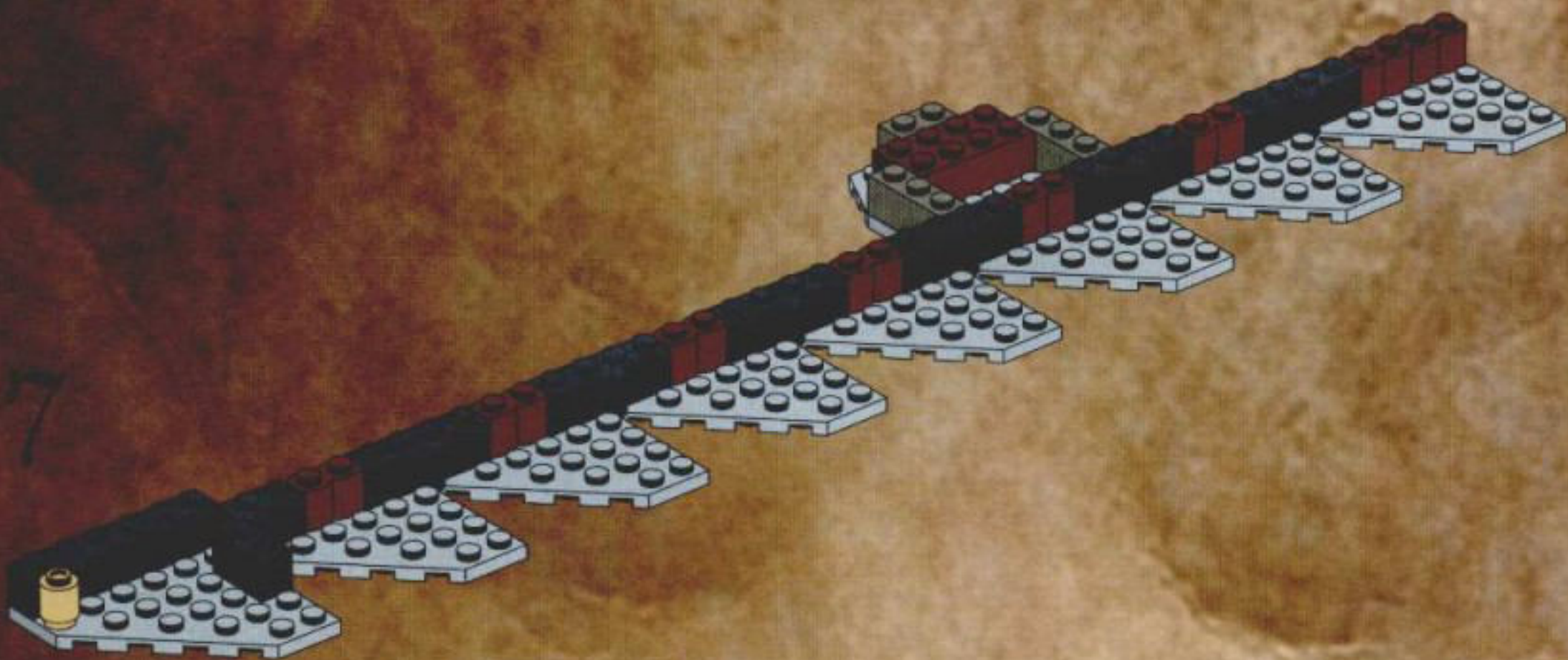

8

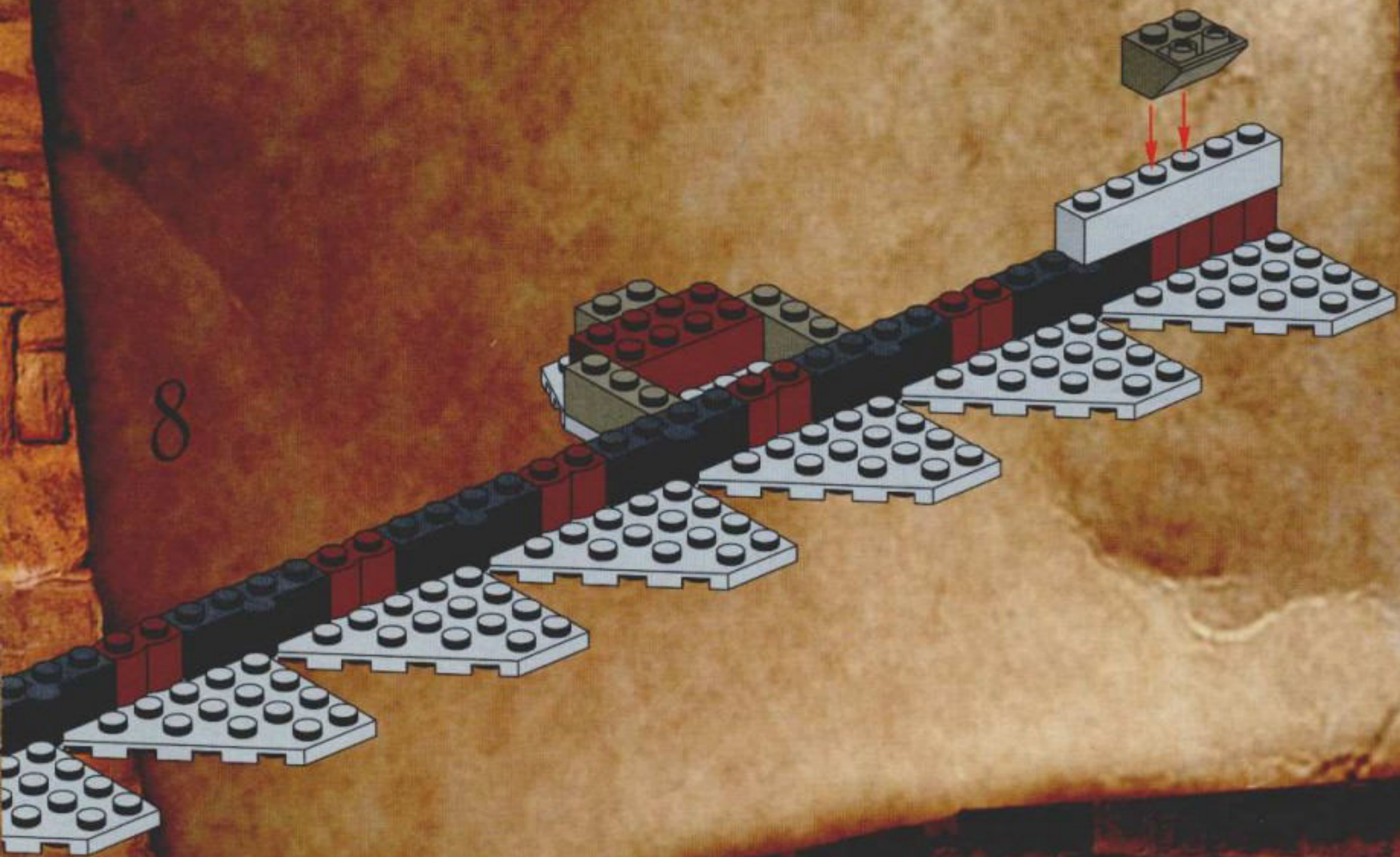

9

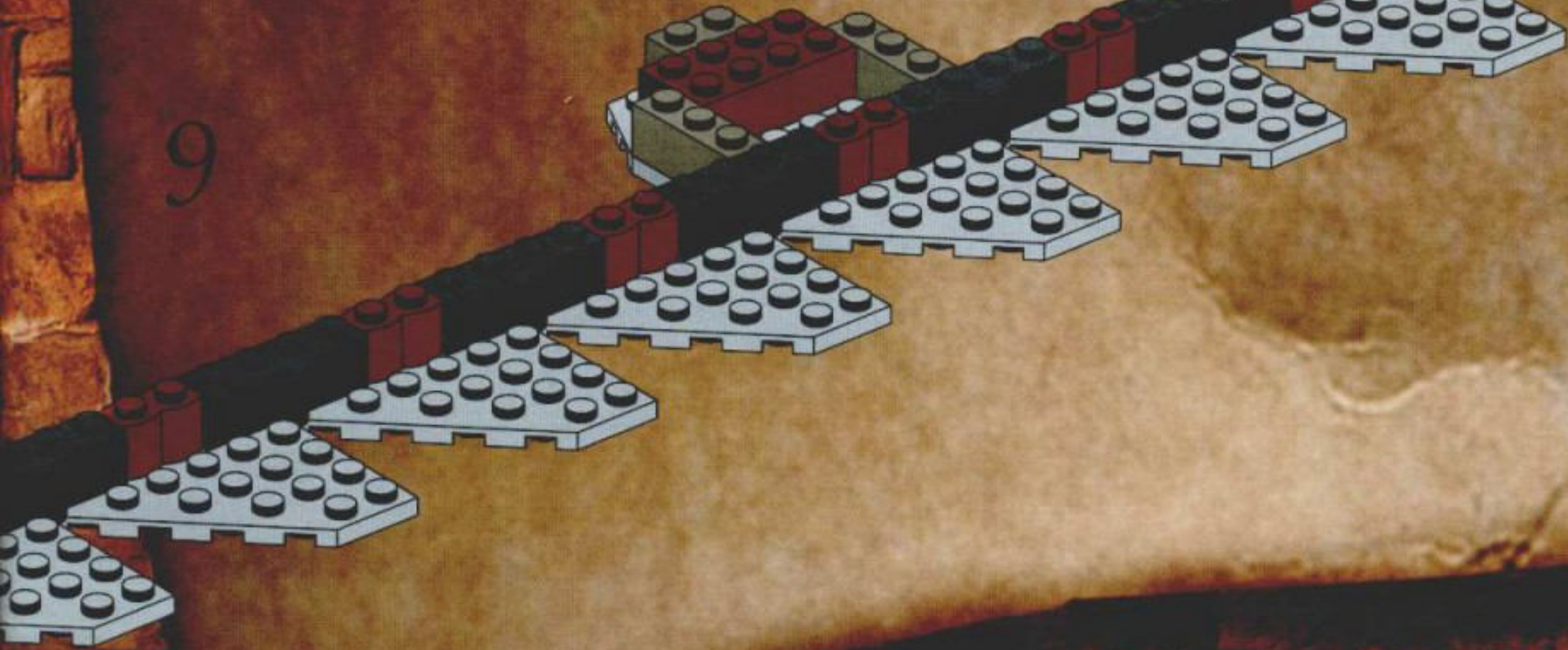
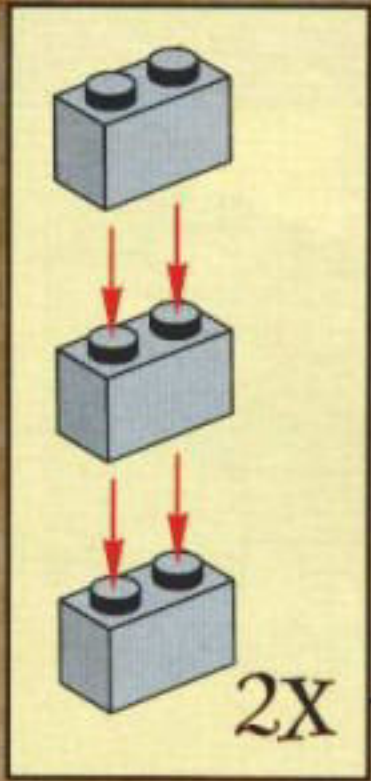

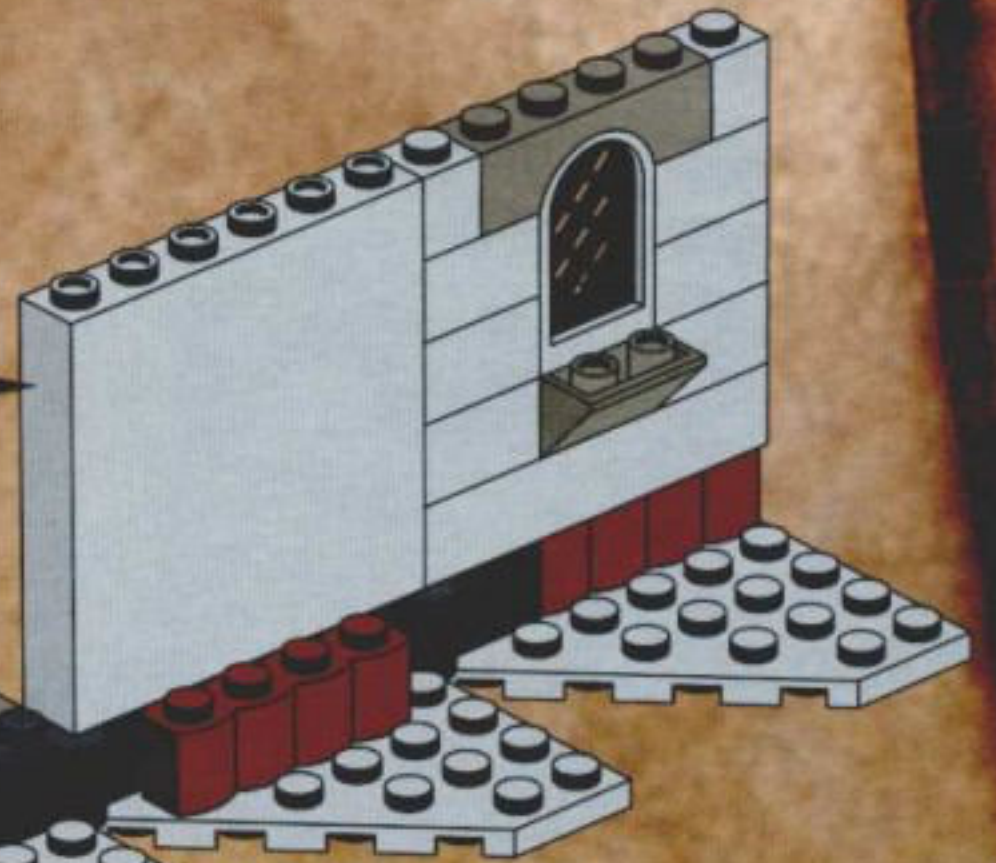
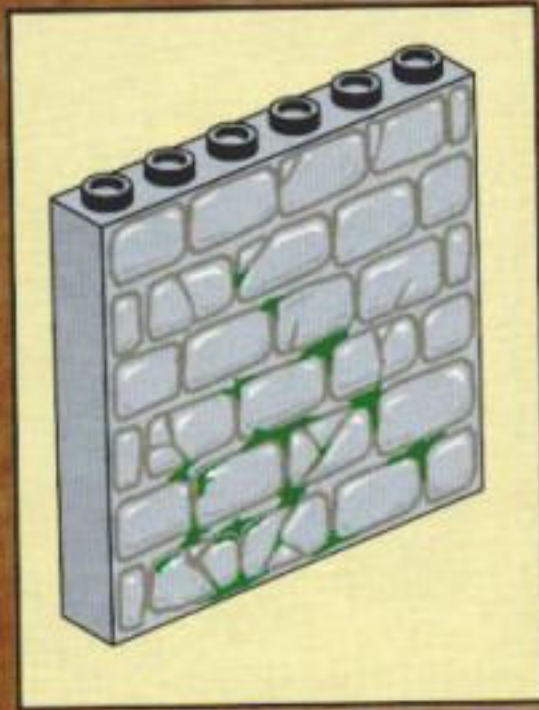

10

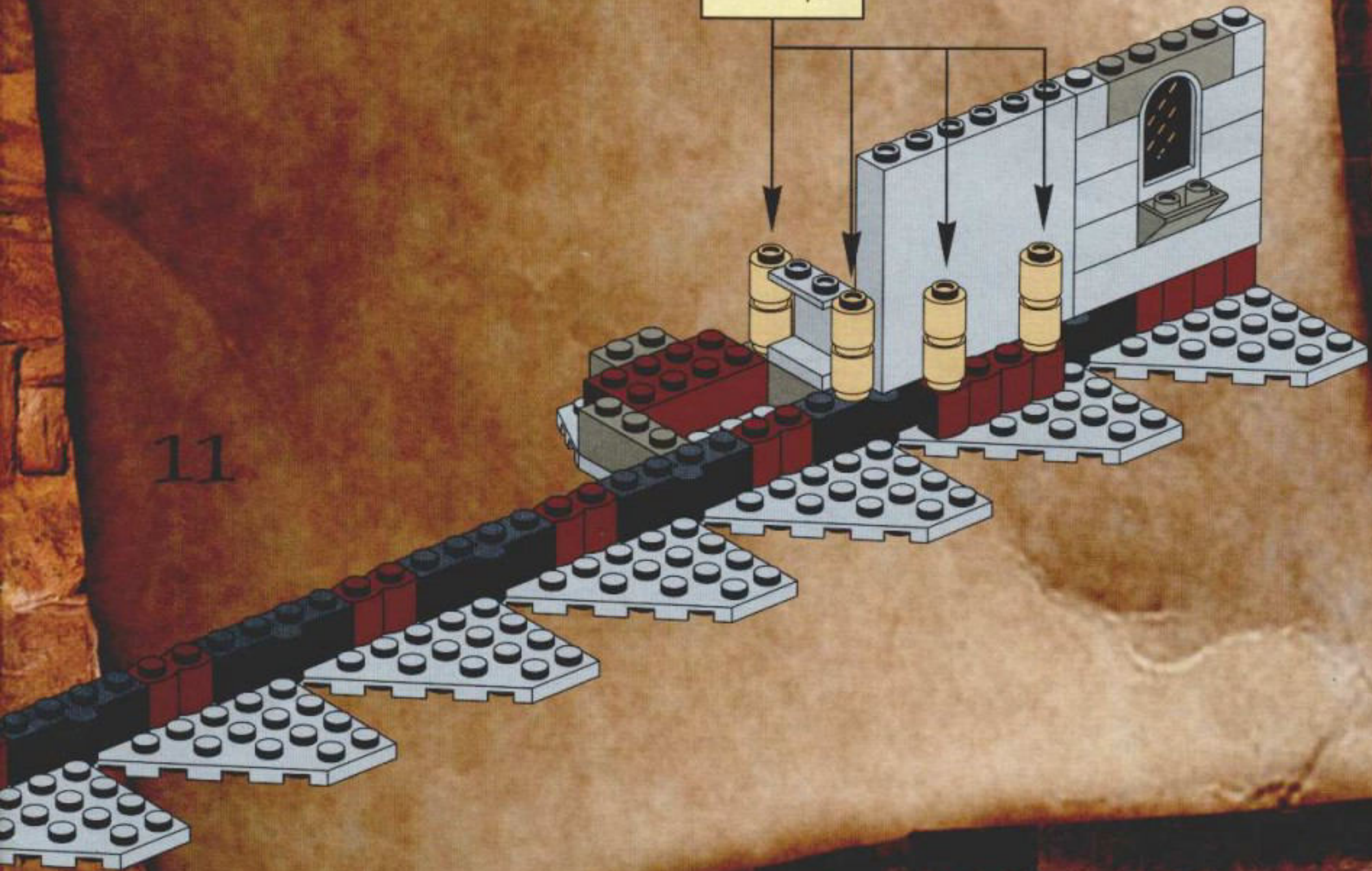
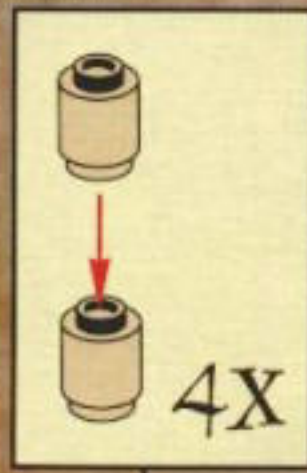

12

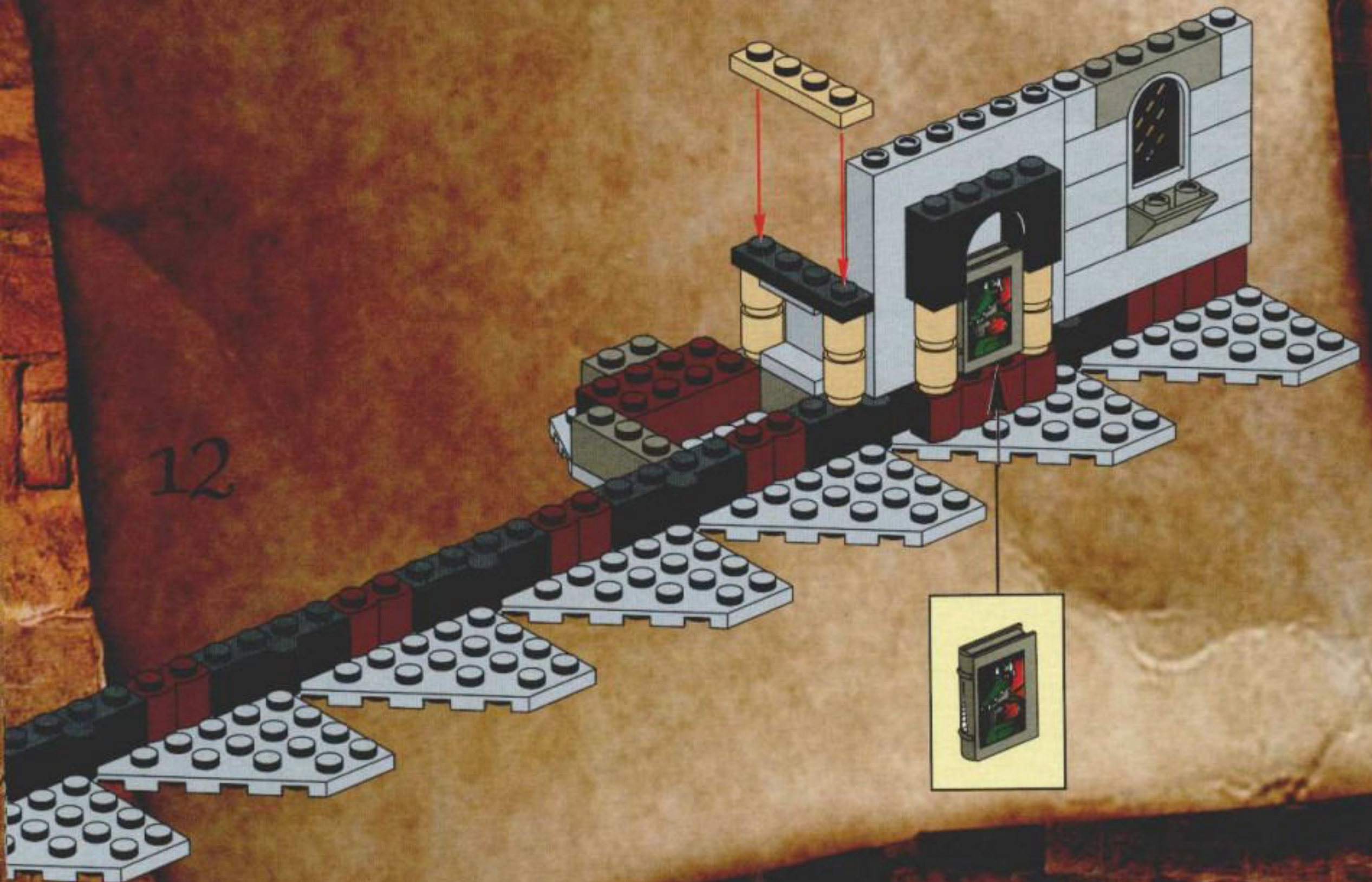

1

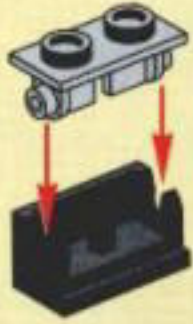

2



3



13

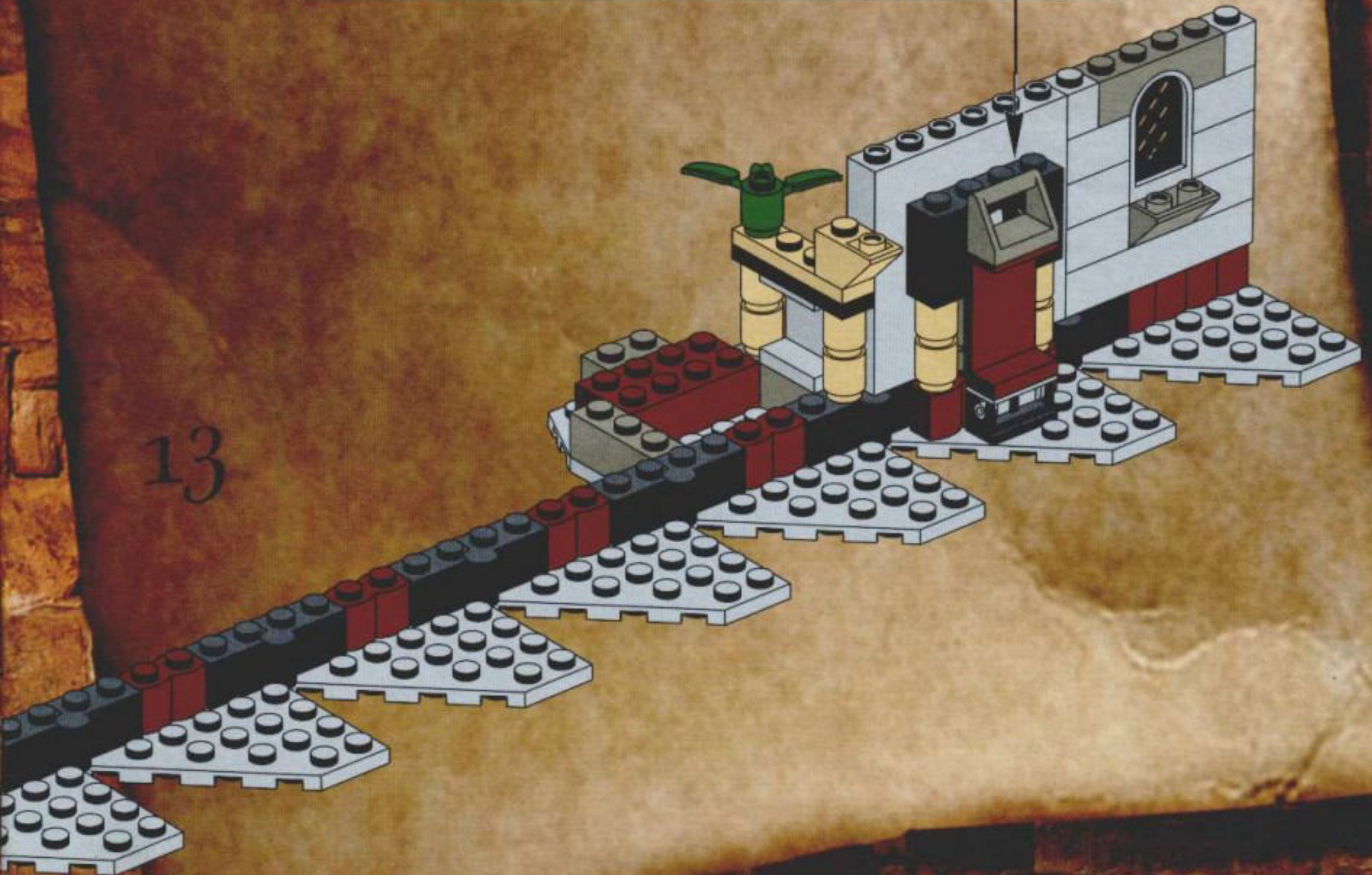

14

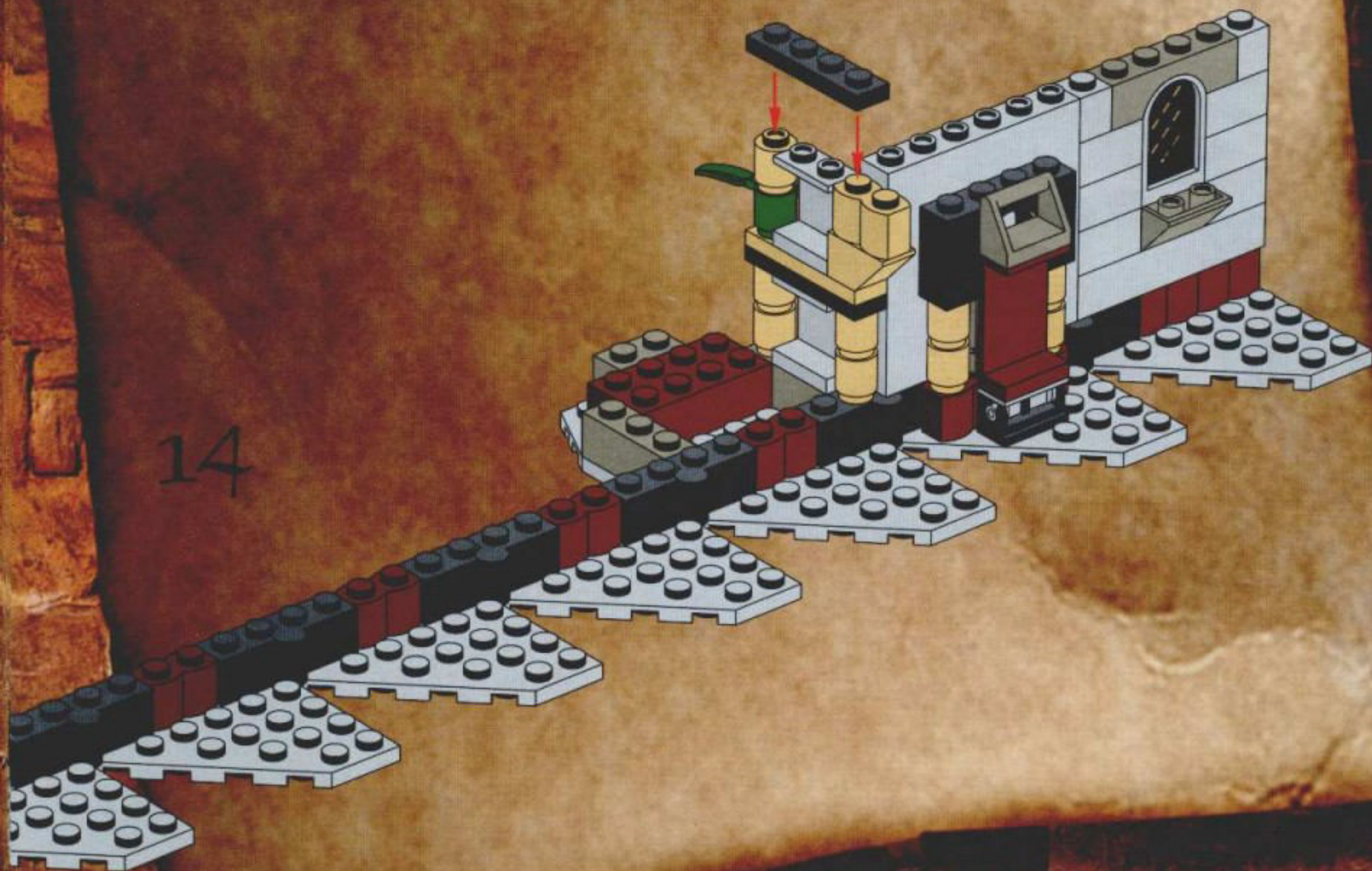

1



2



3



4

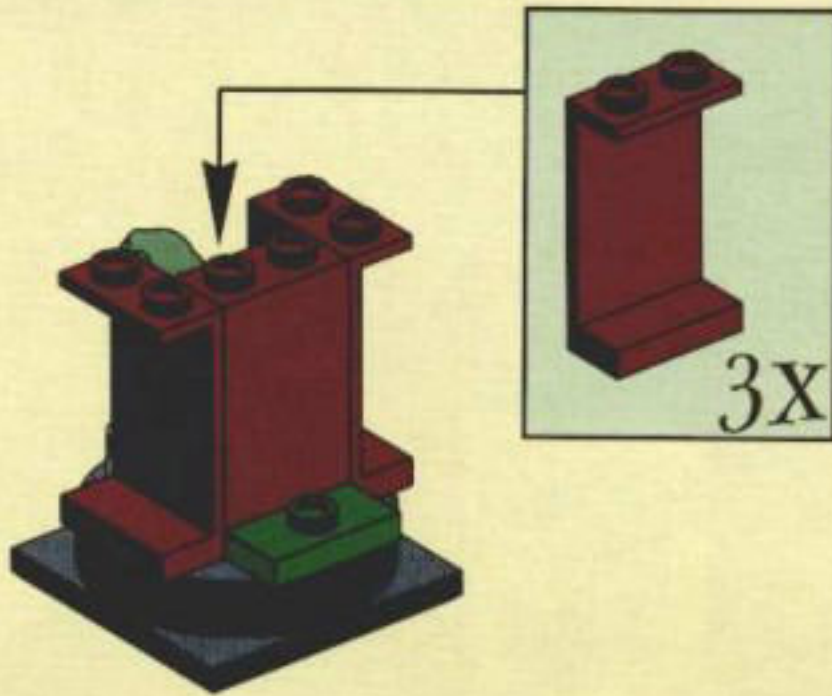

5



15

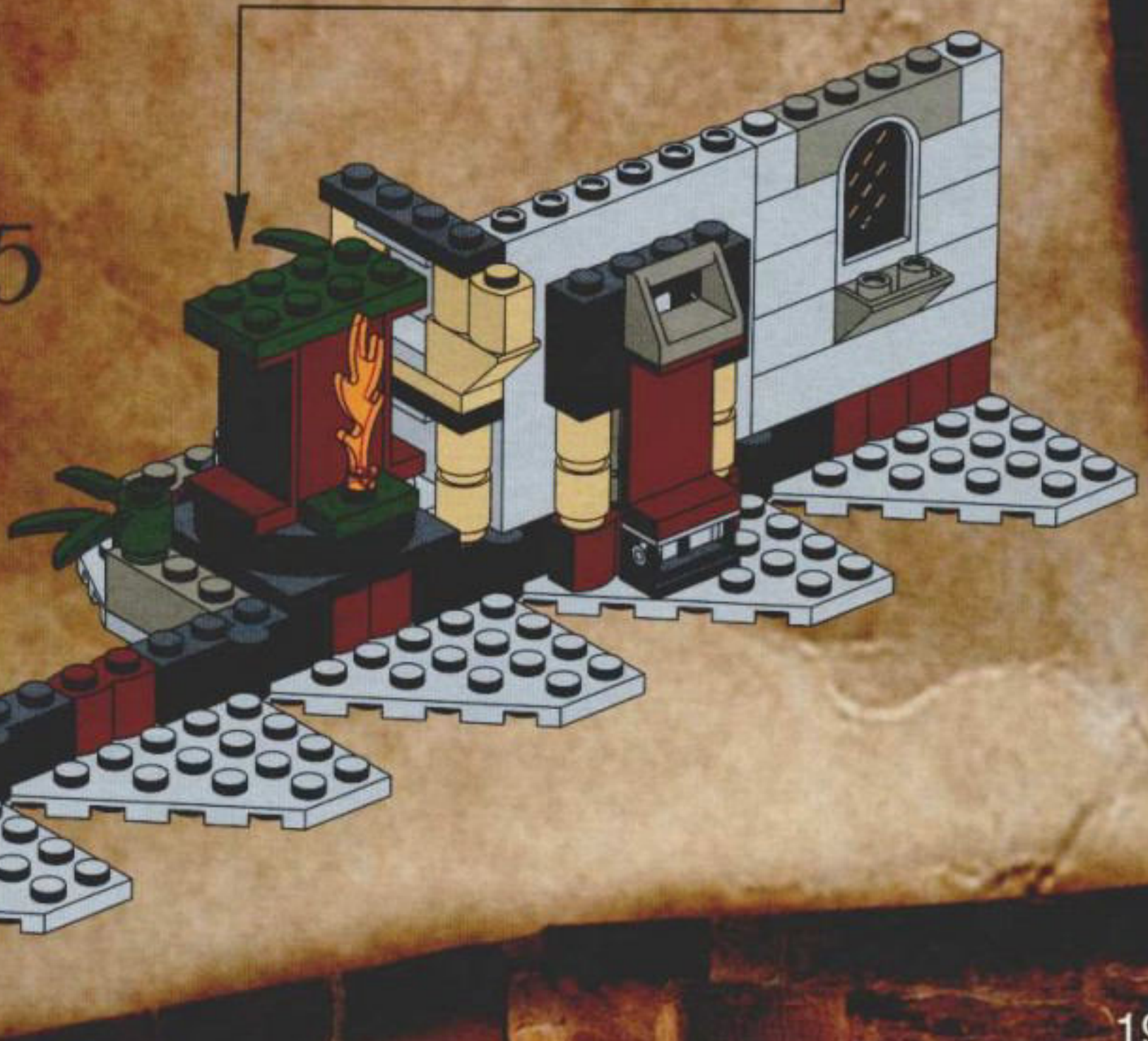

16

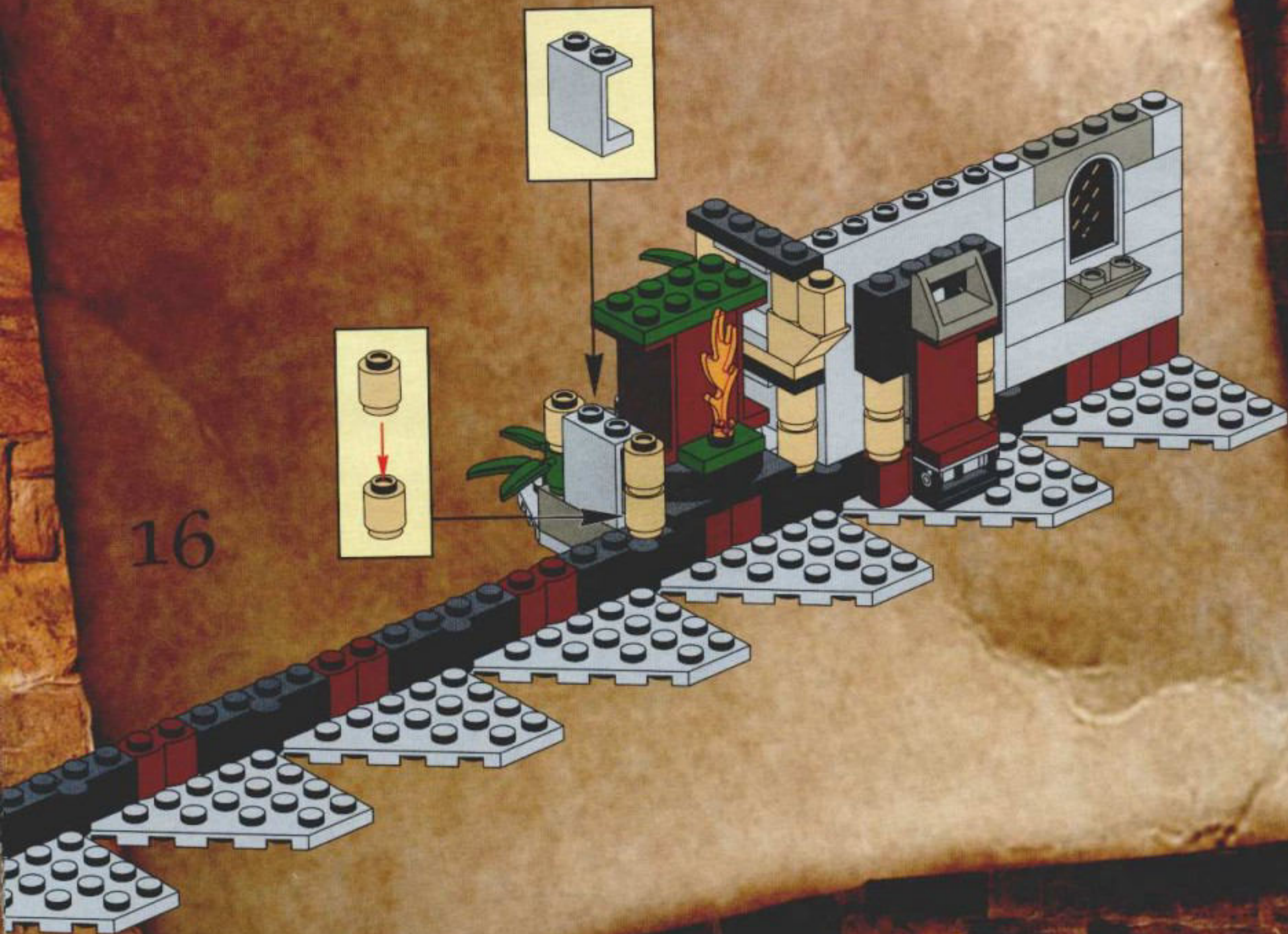

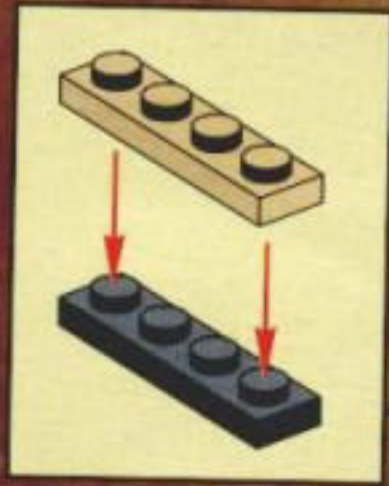

17

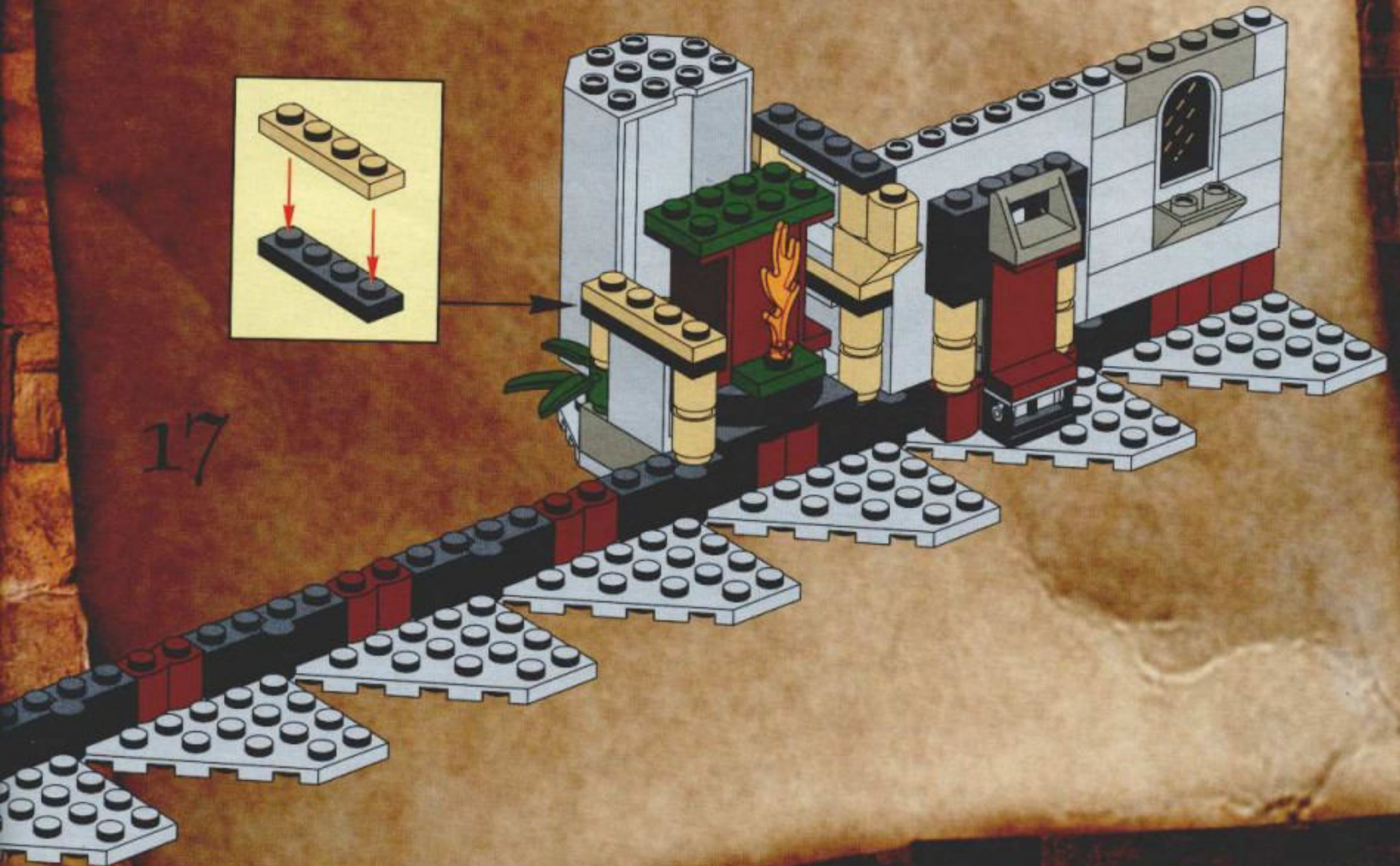

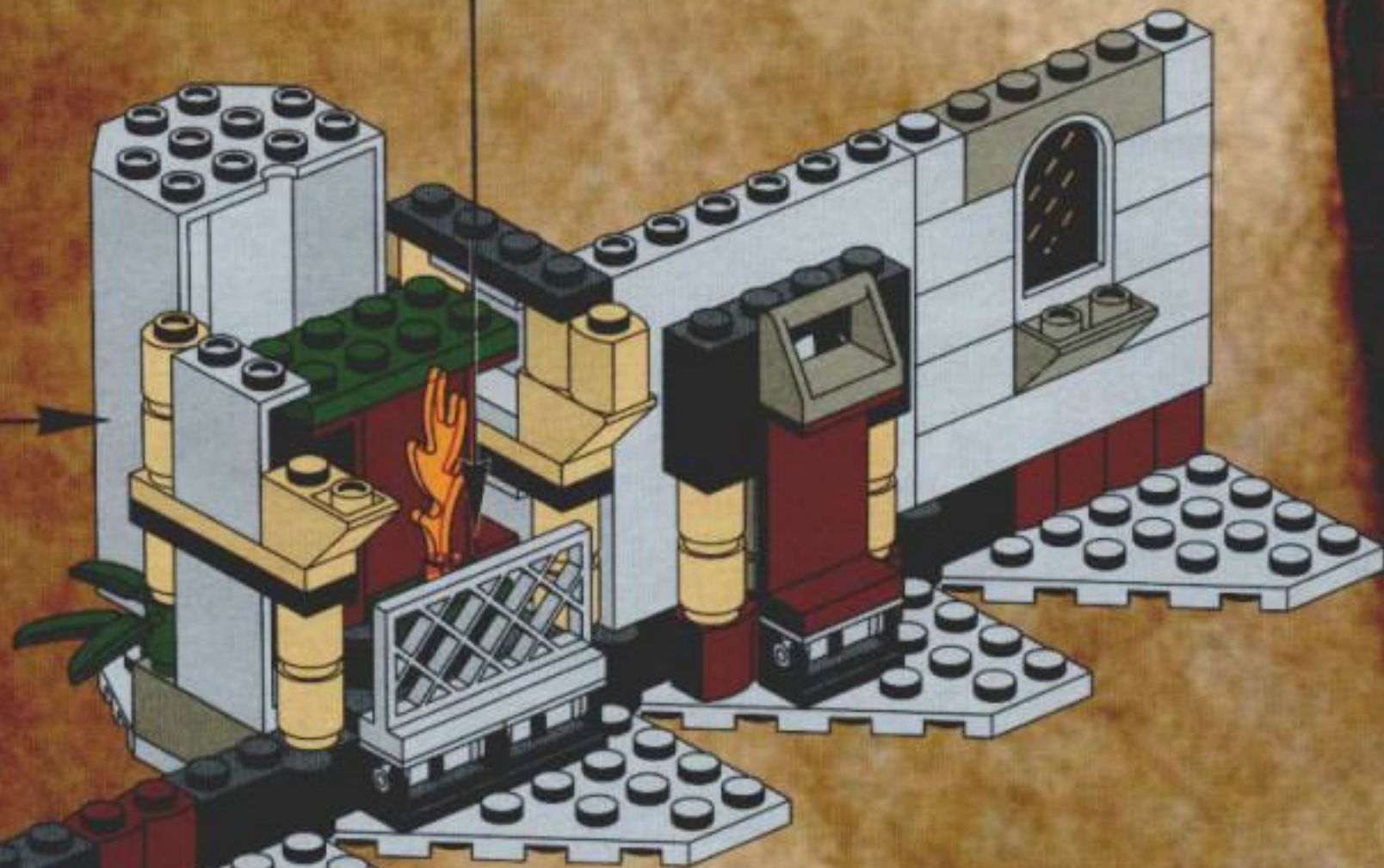
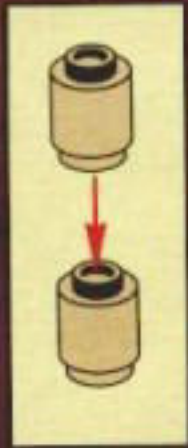
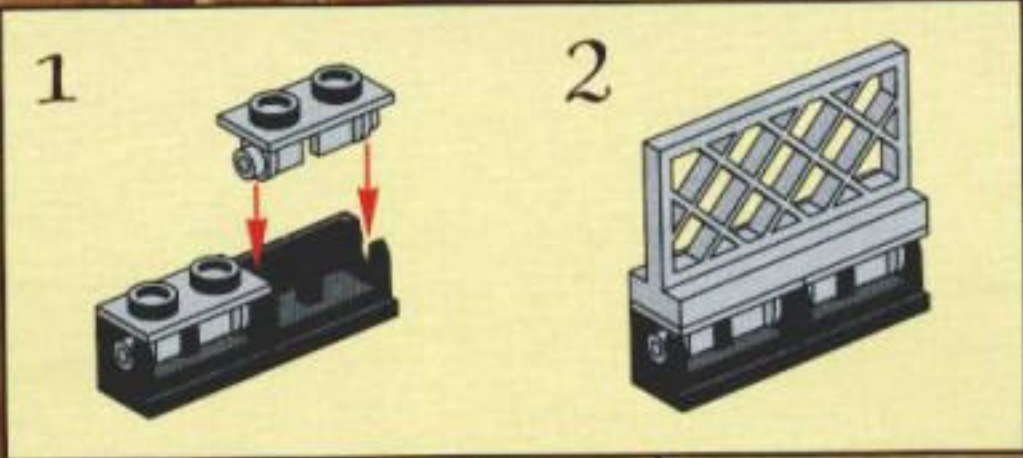

18

19

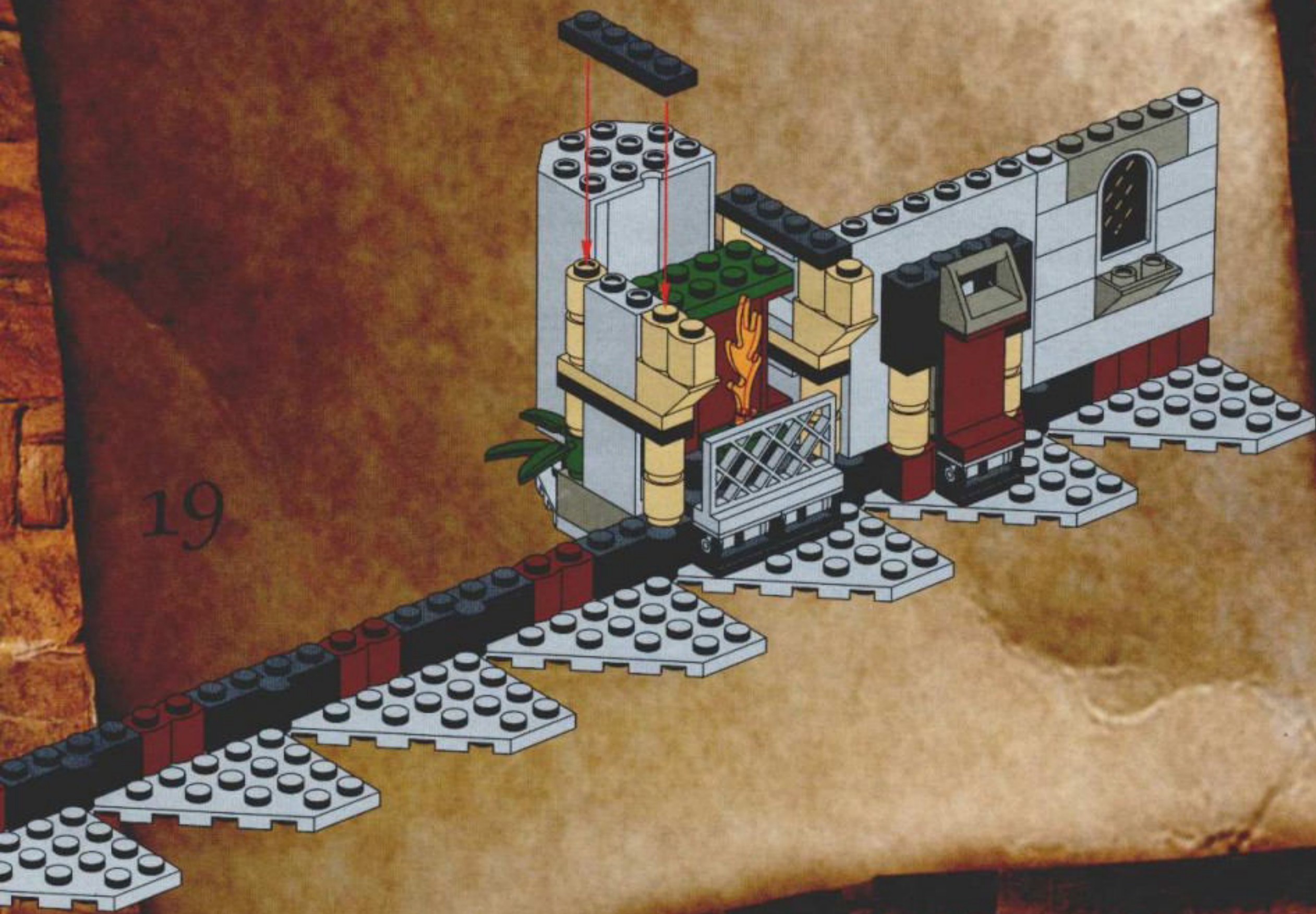

20

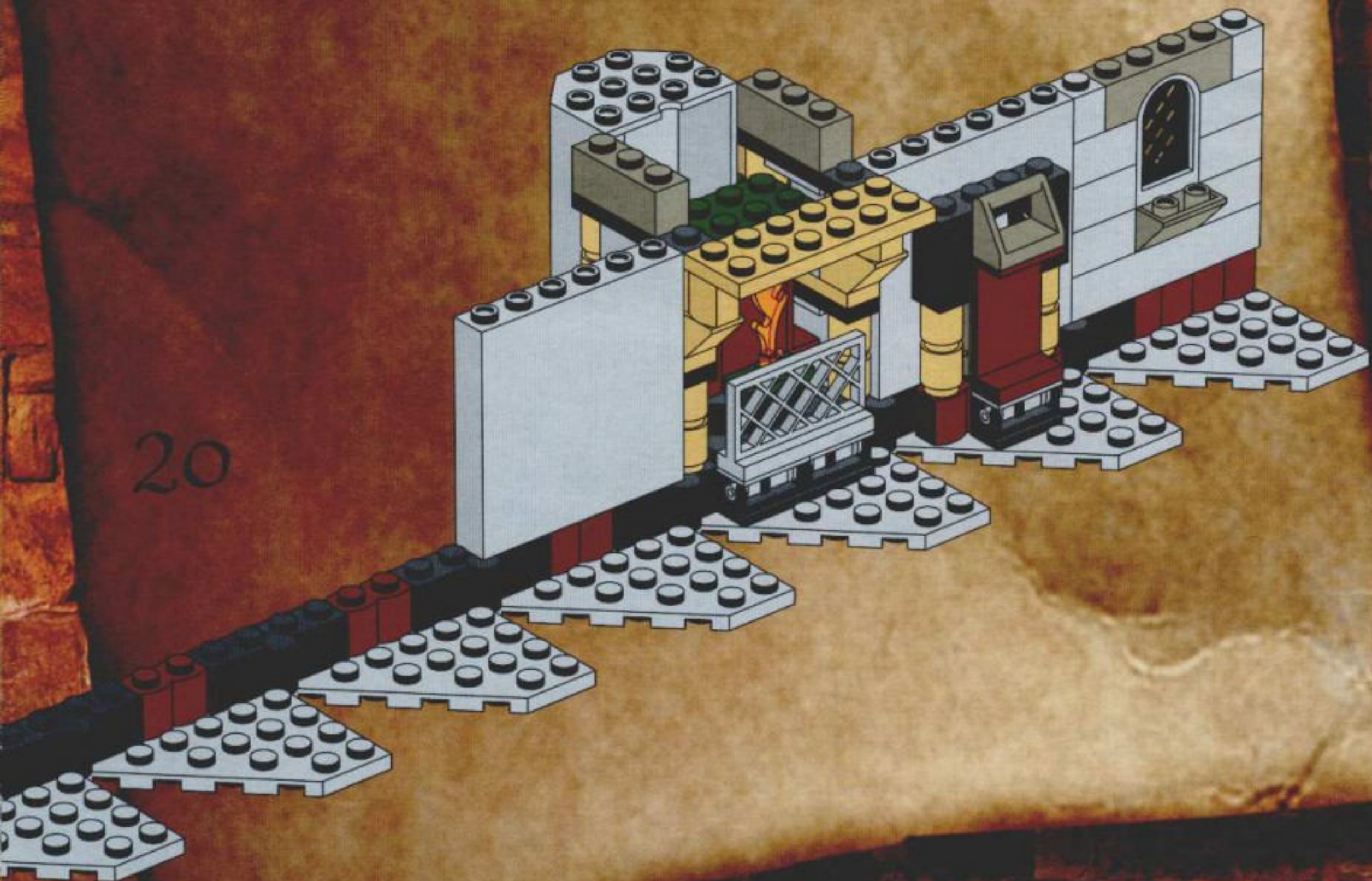

21

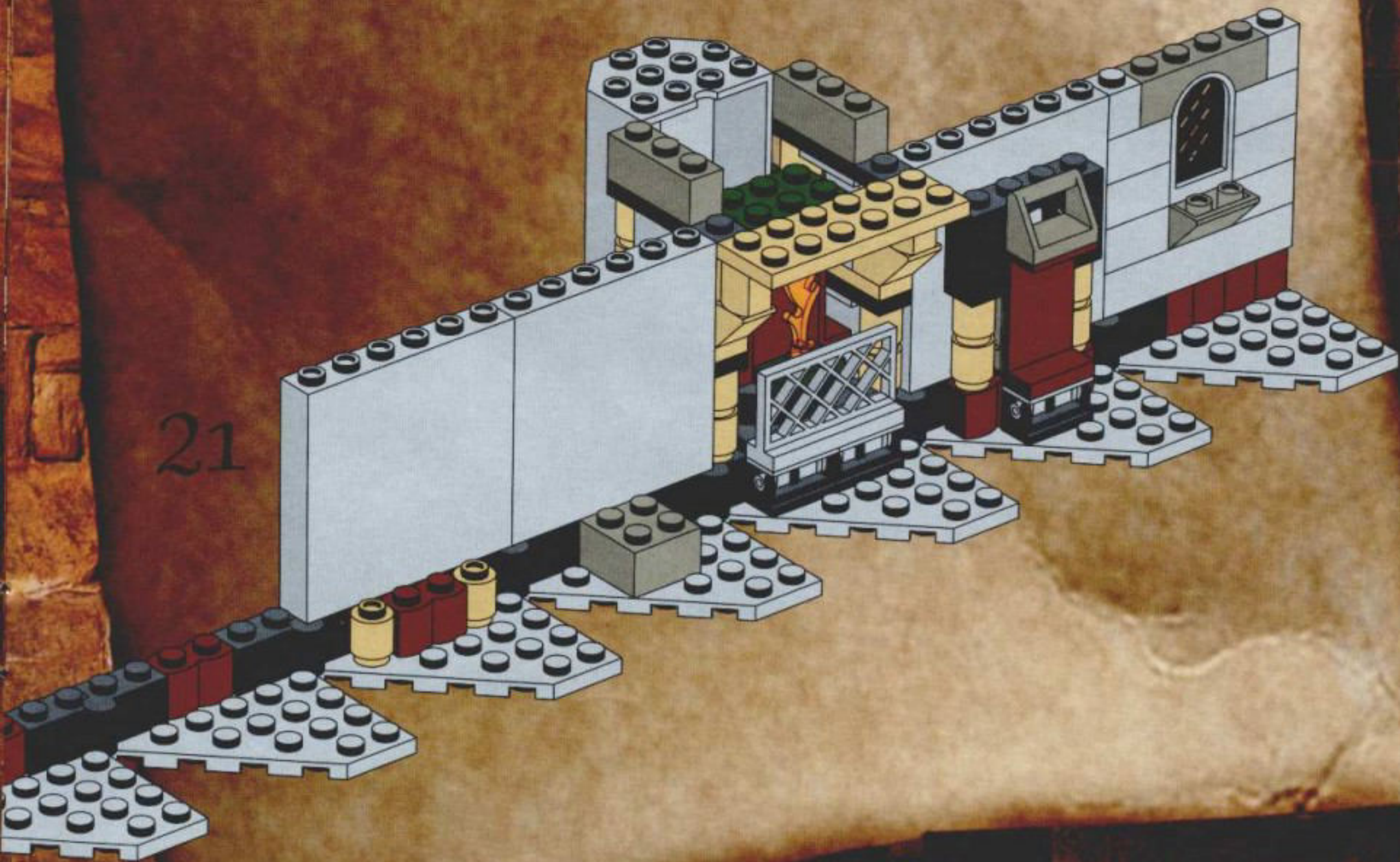

22

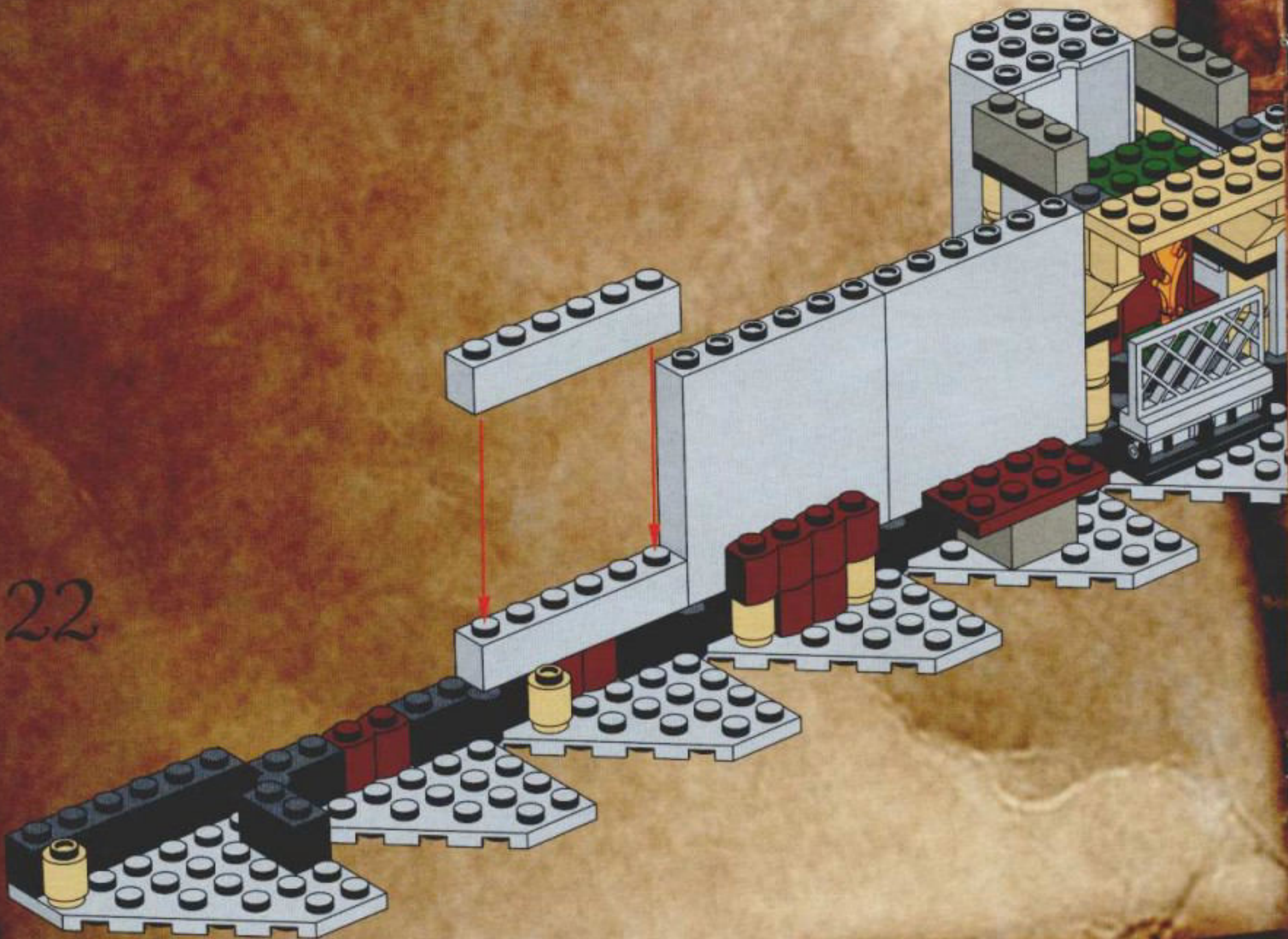

23

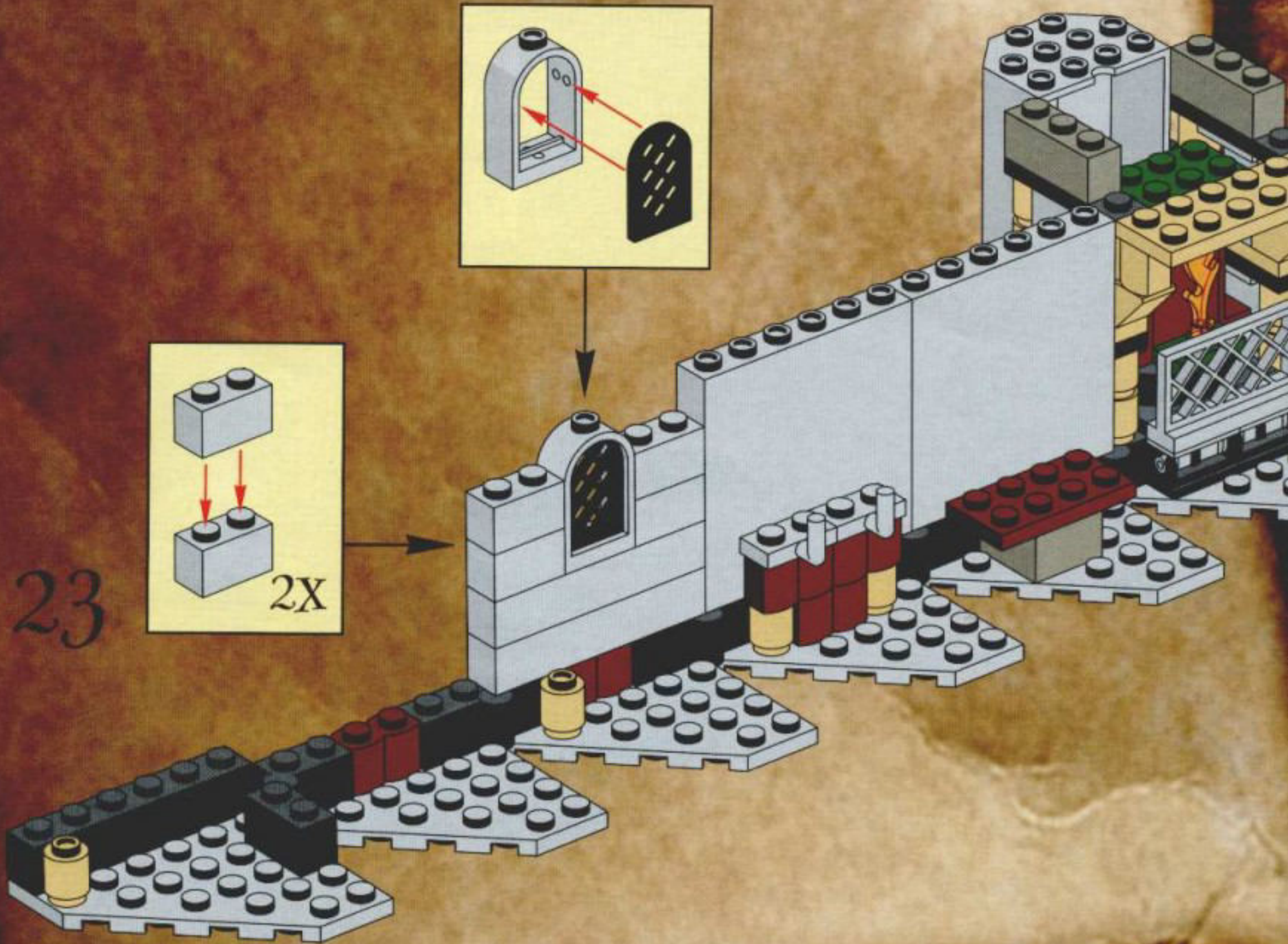

24

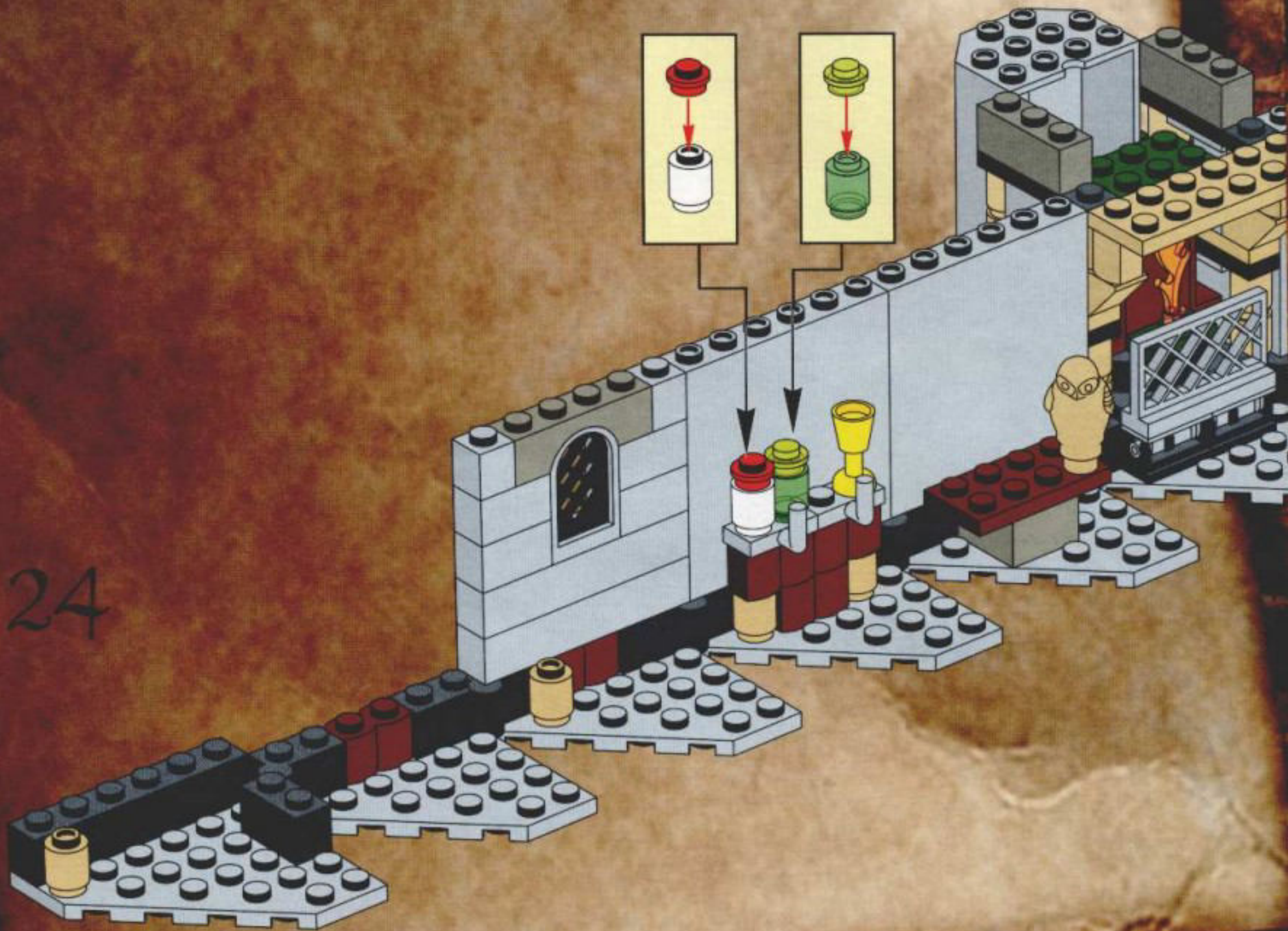

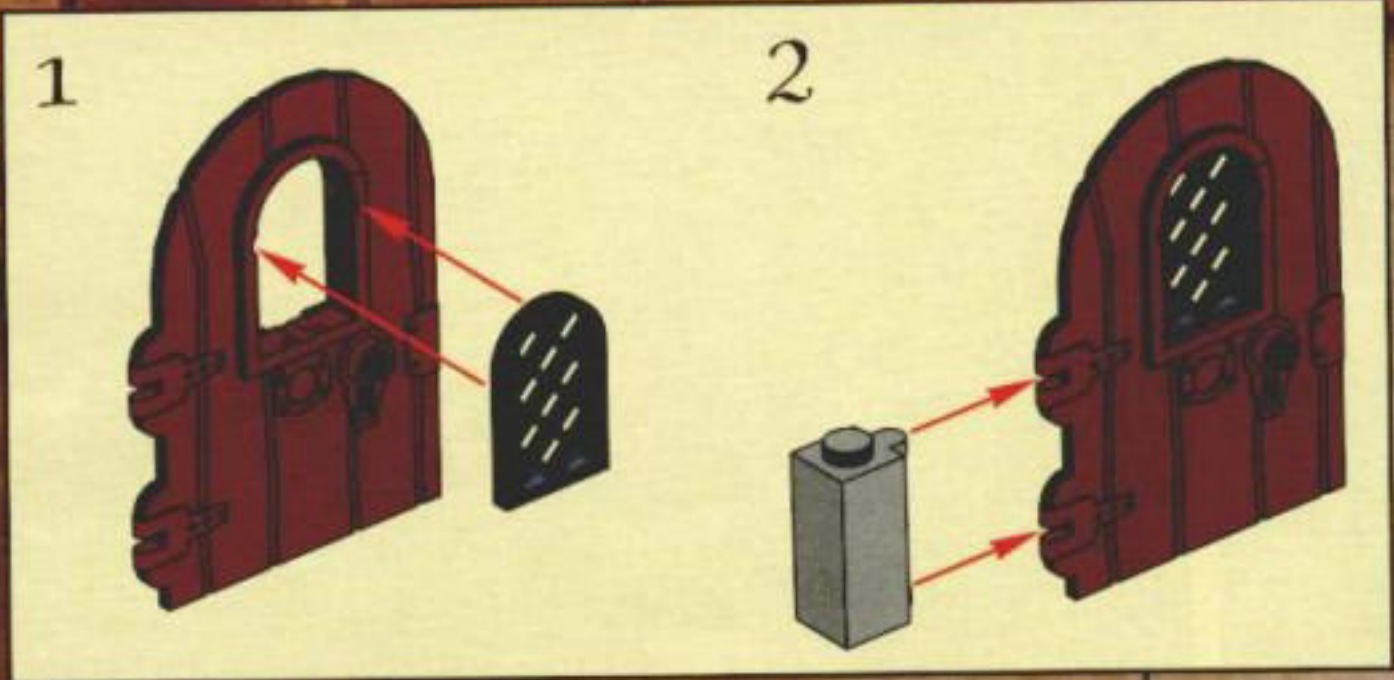

26

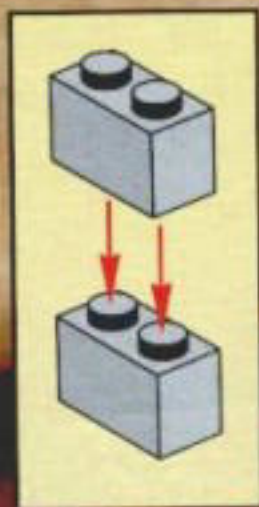
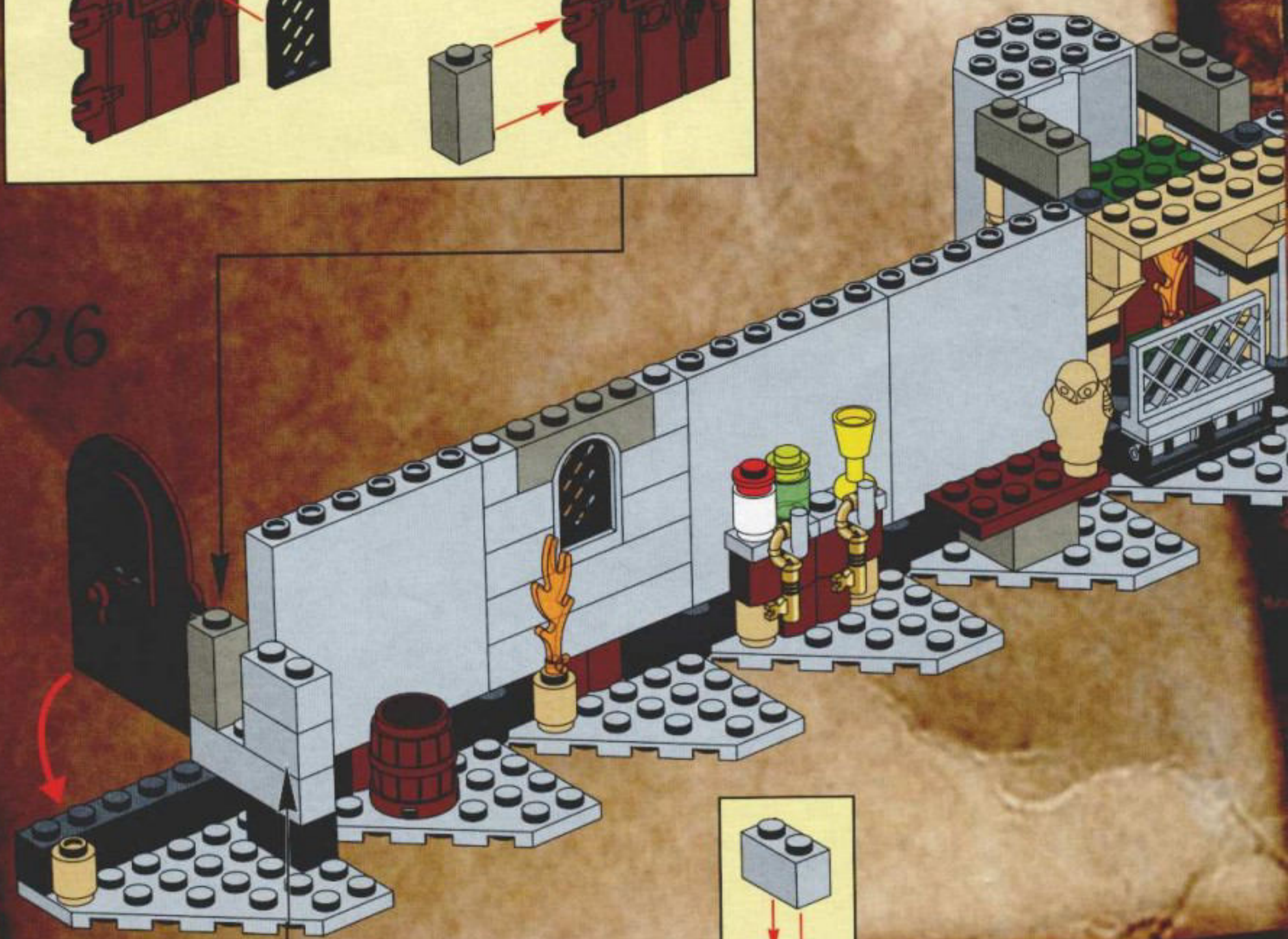

27

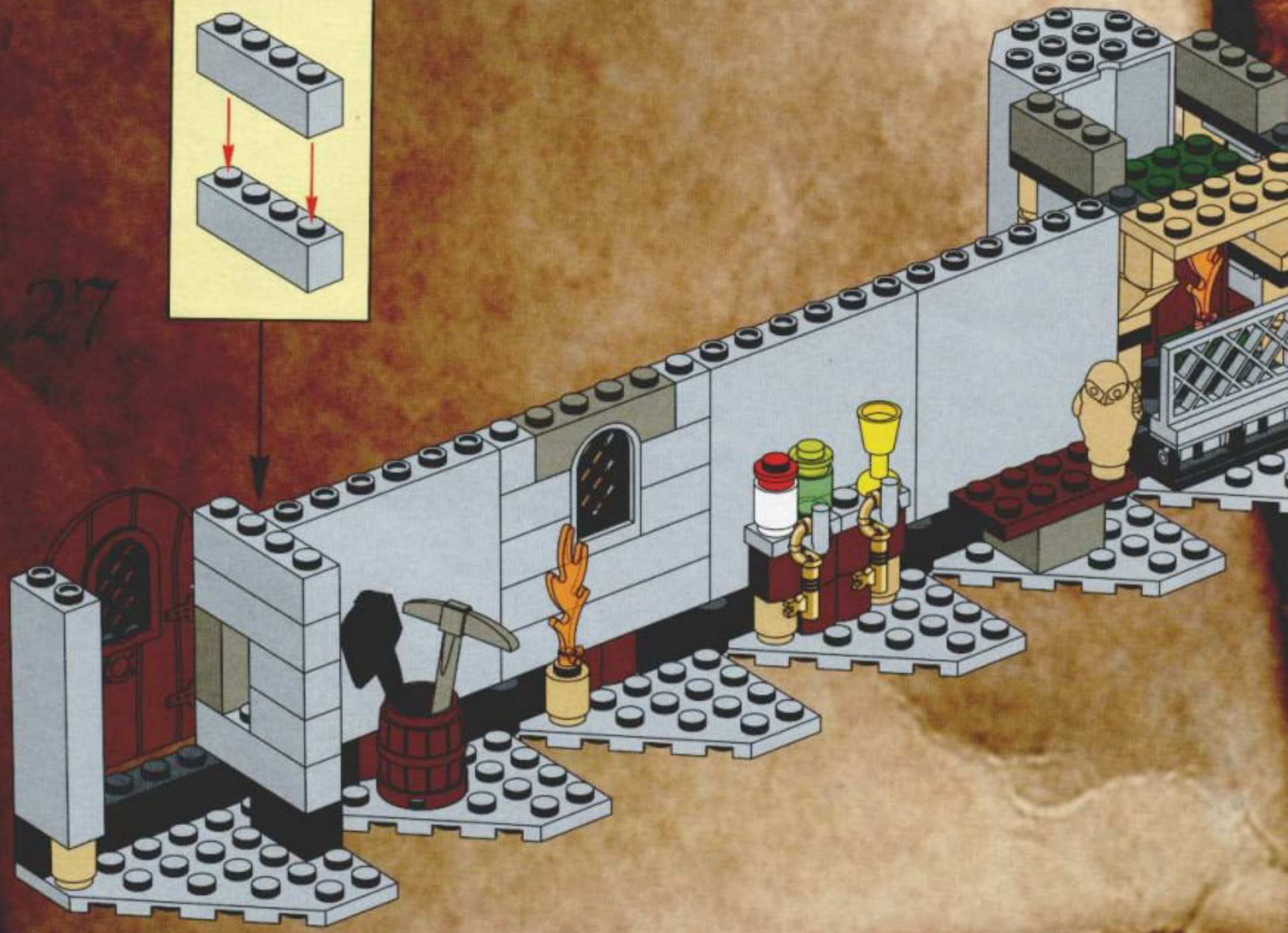
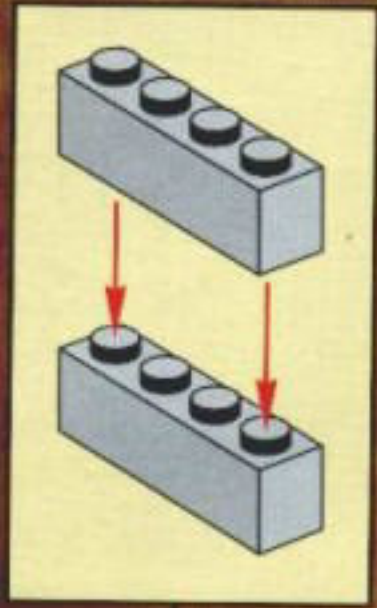

28

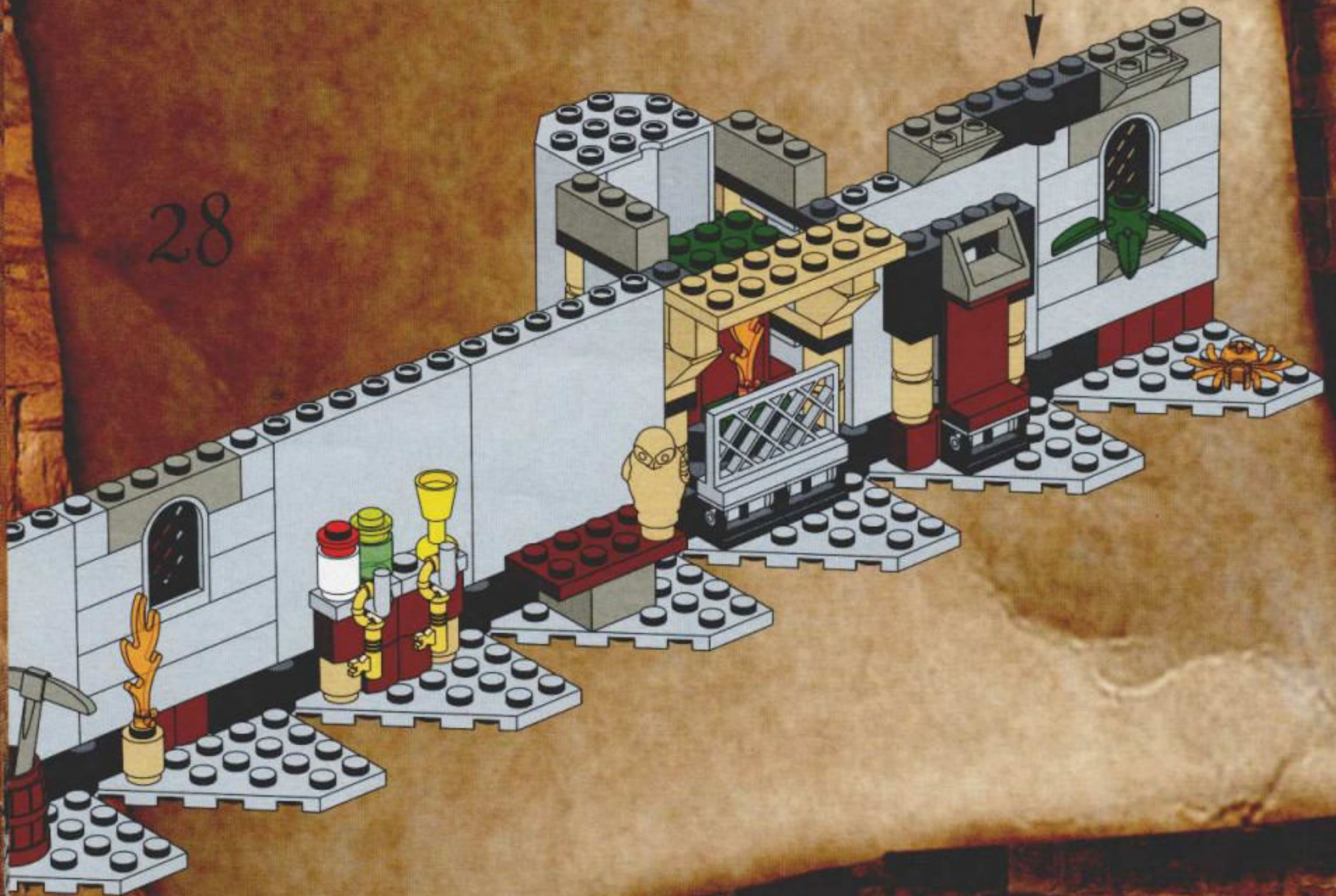
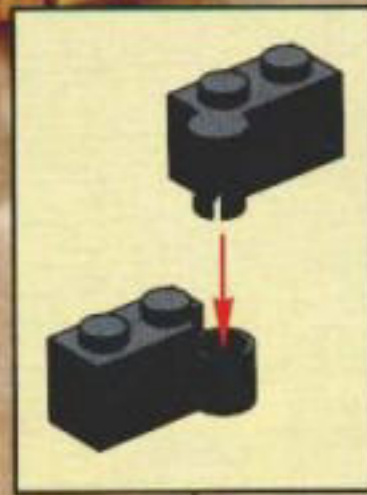

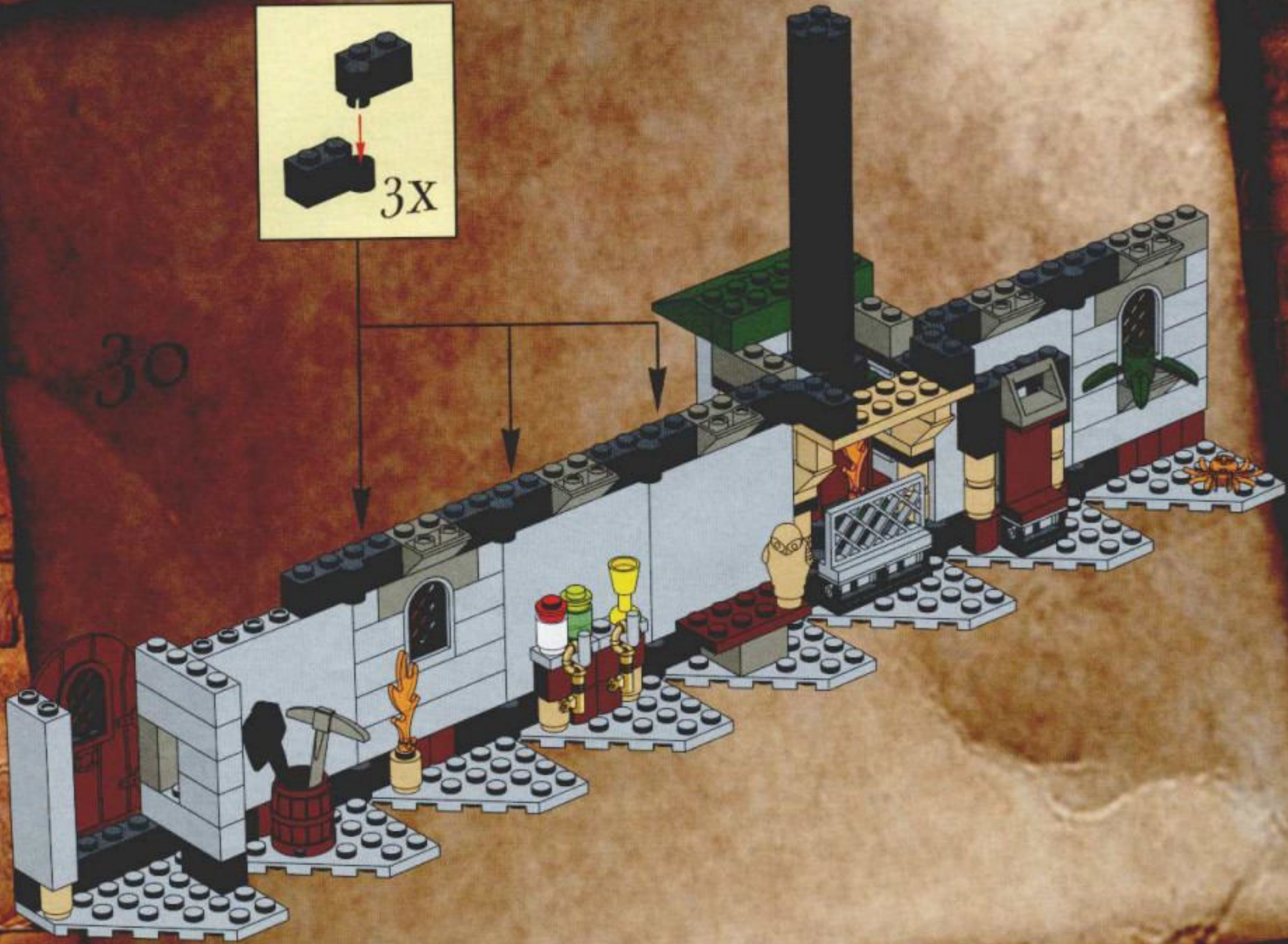
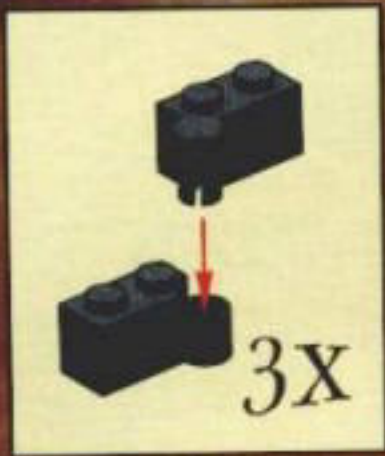

31

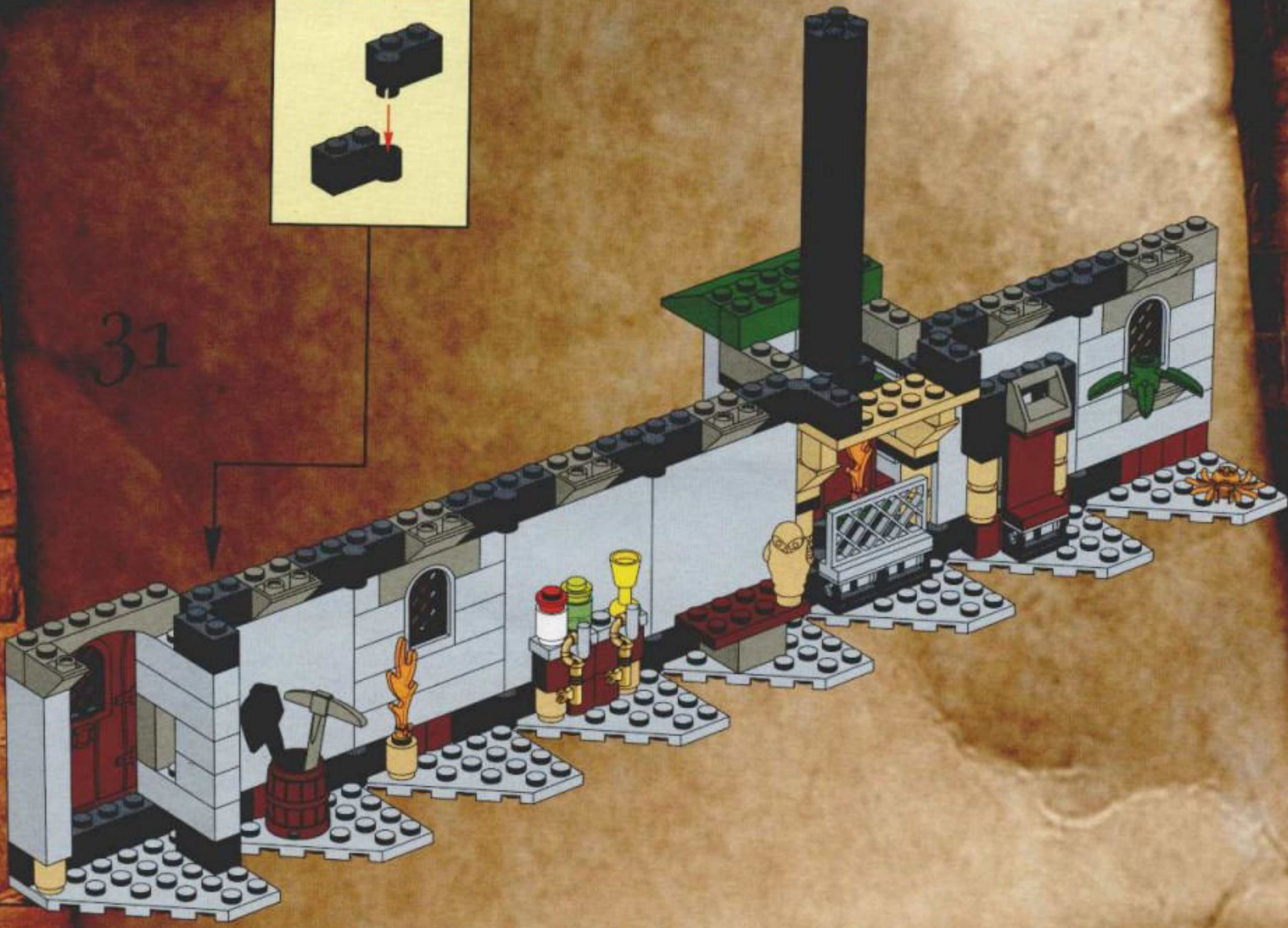
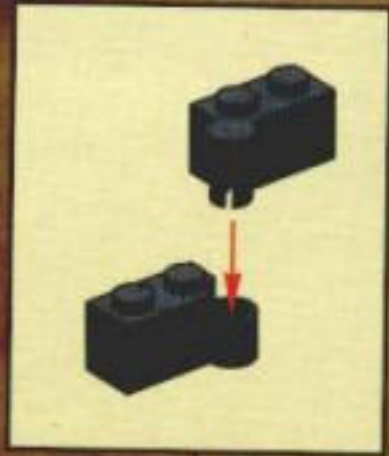

32

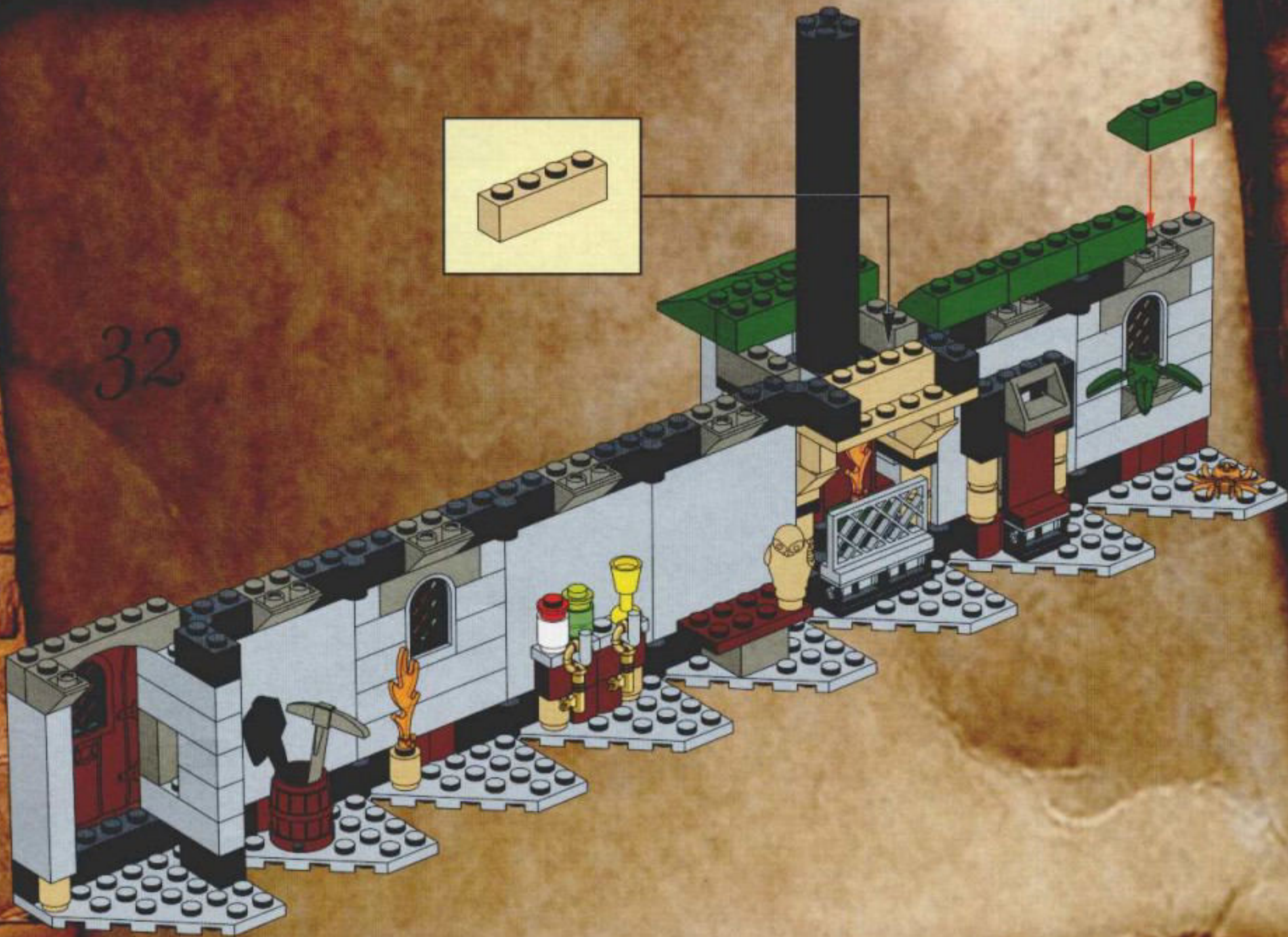

33

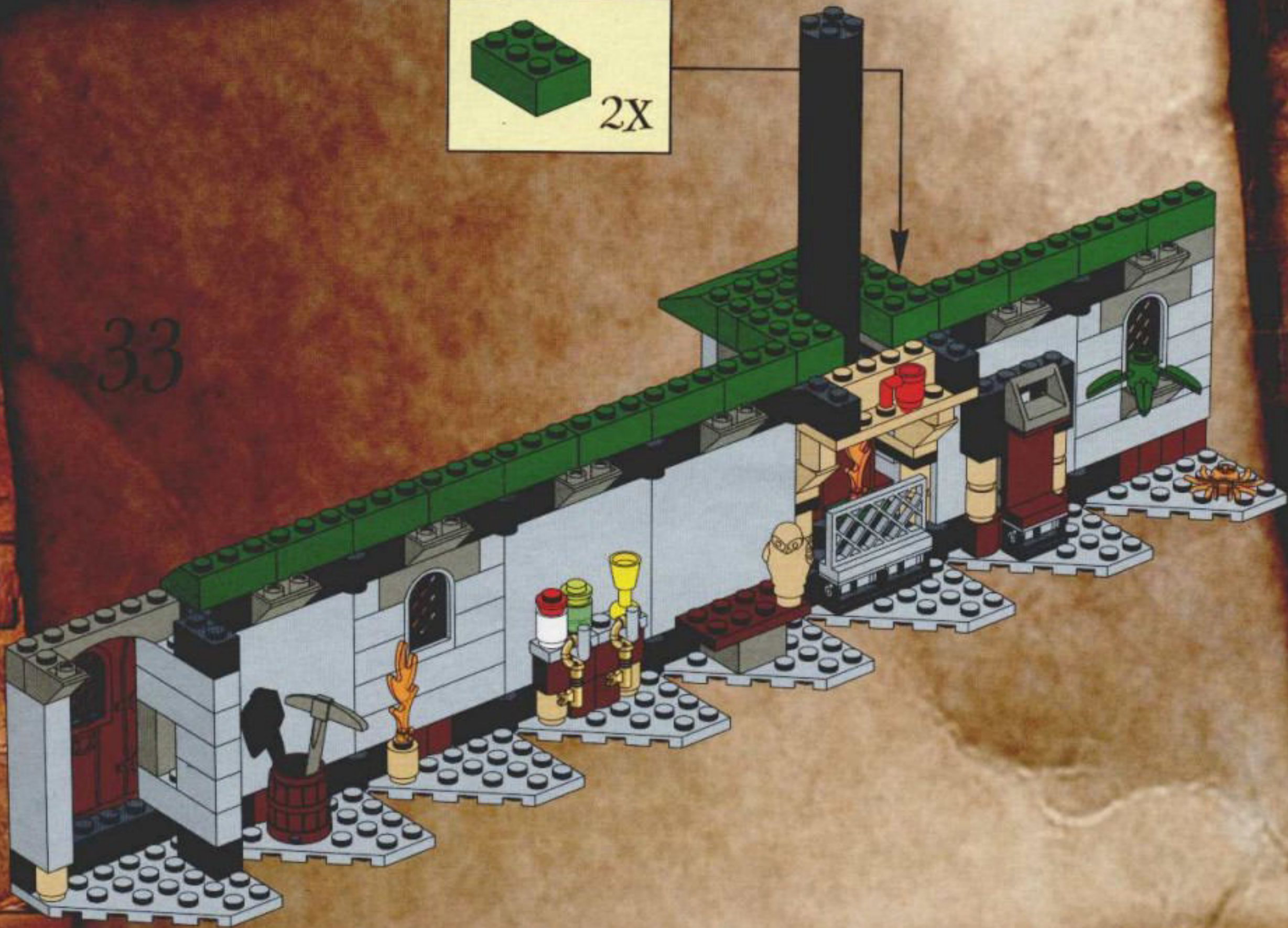
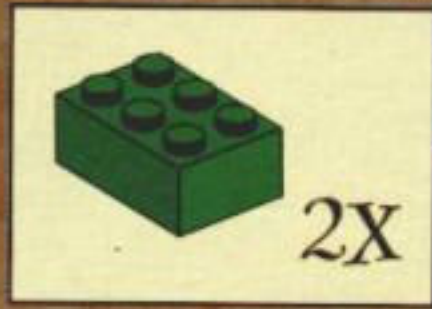

34

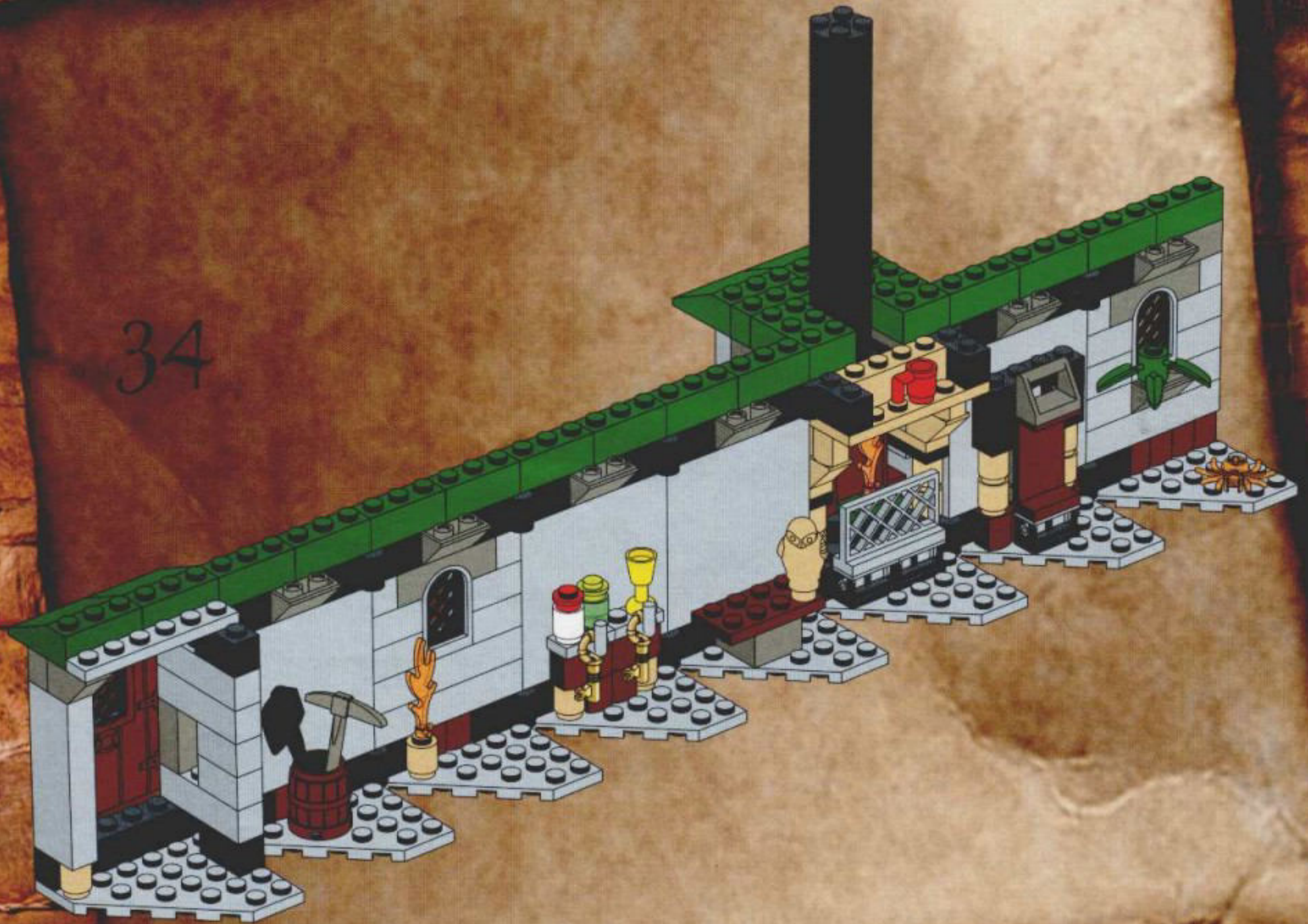

35

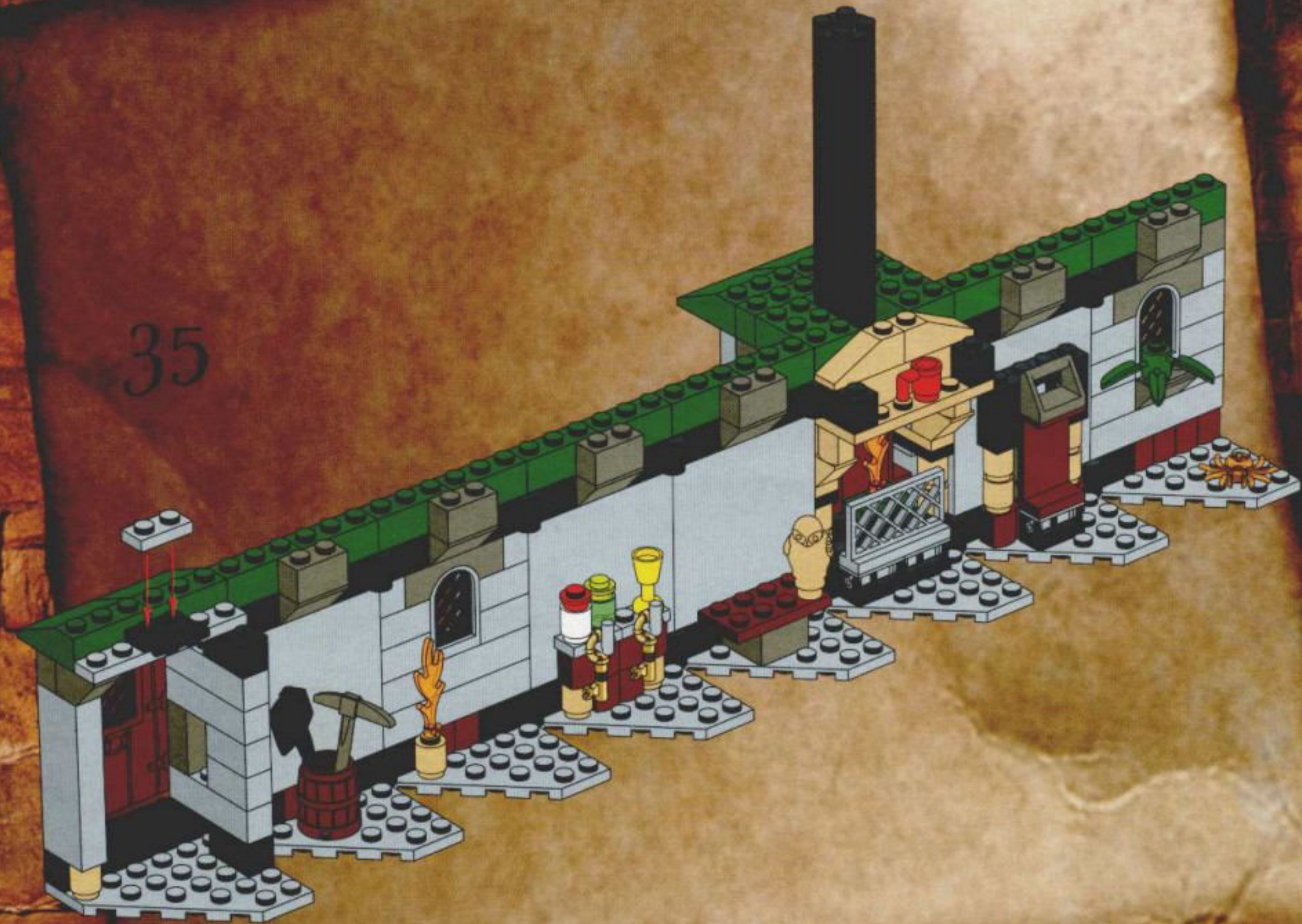

36

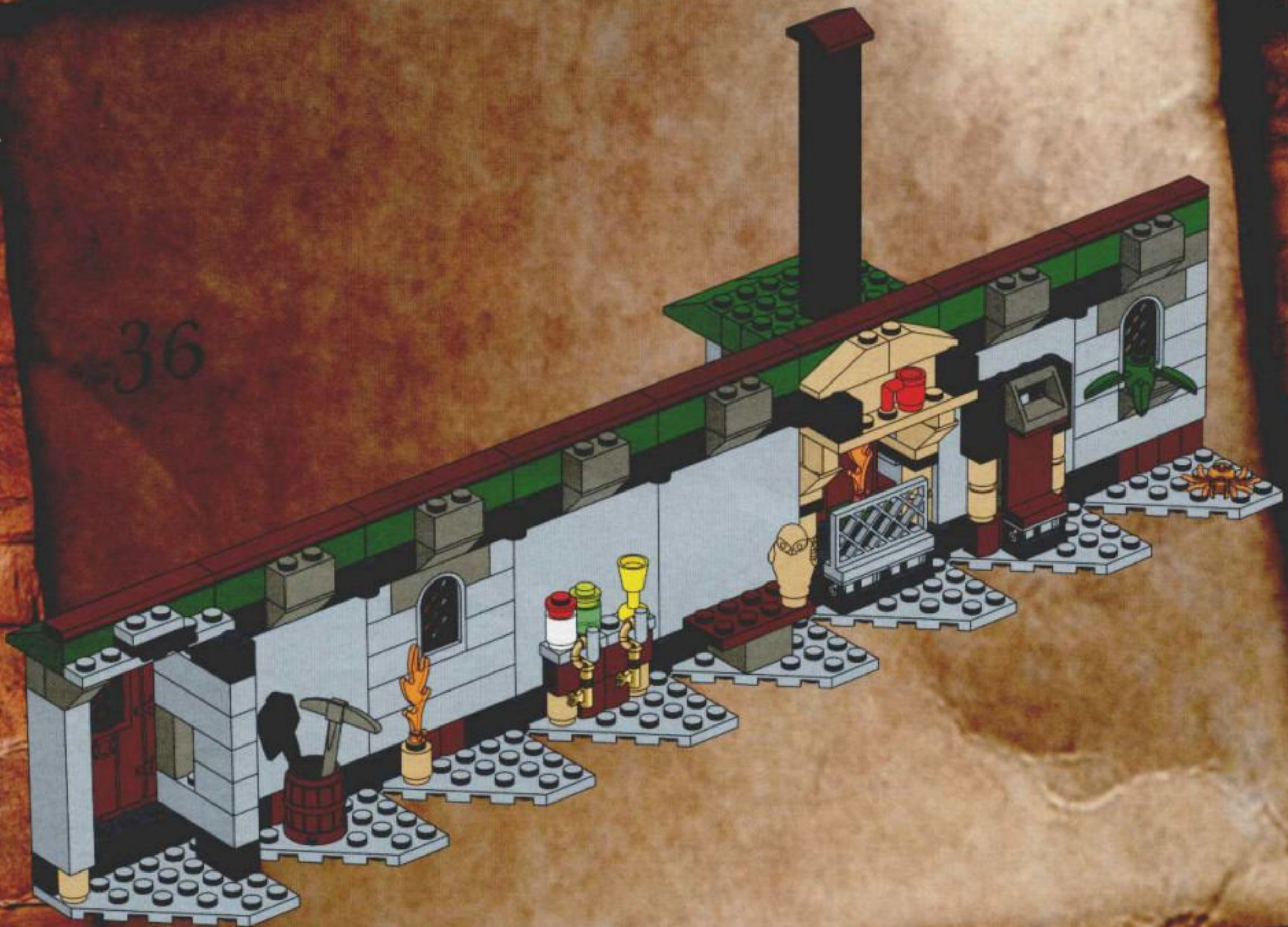

37

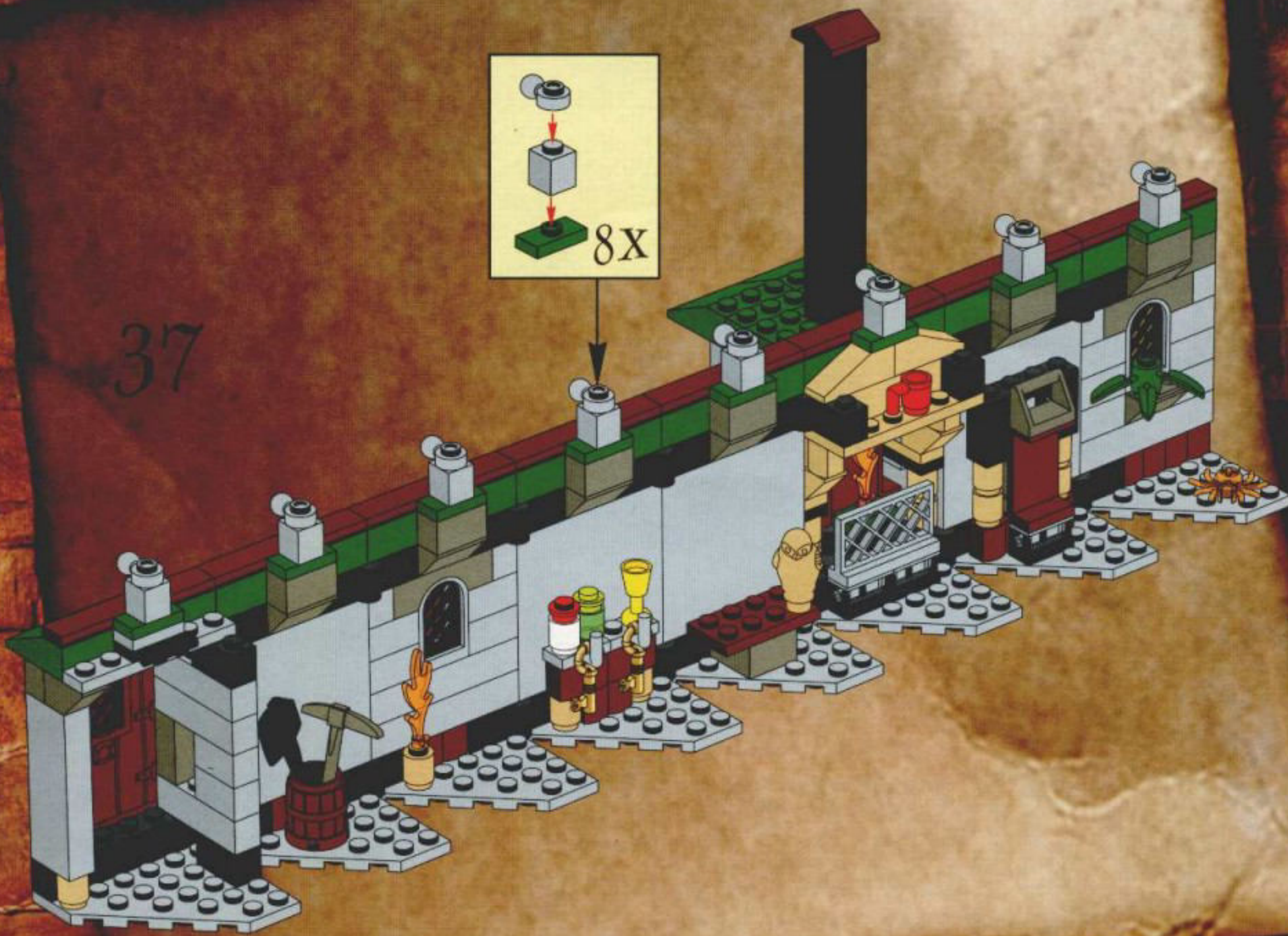
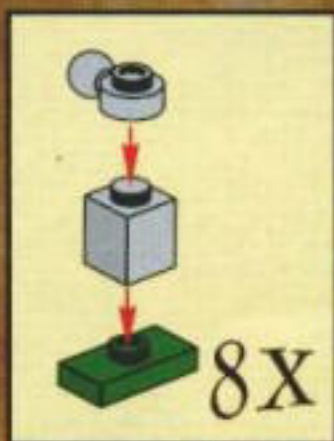

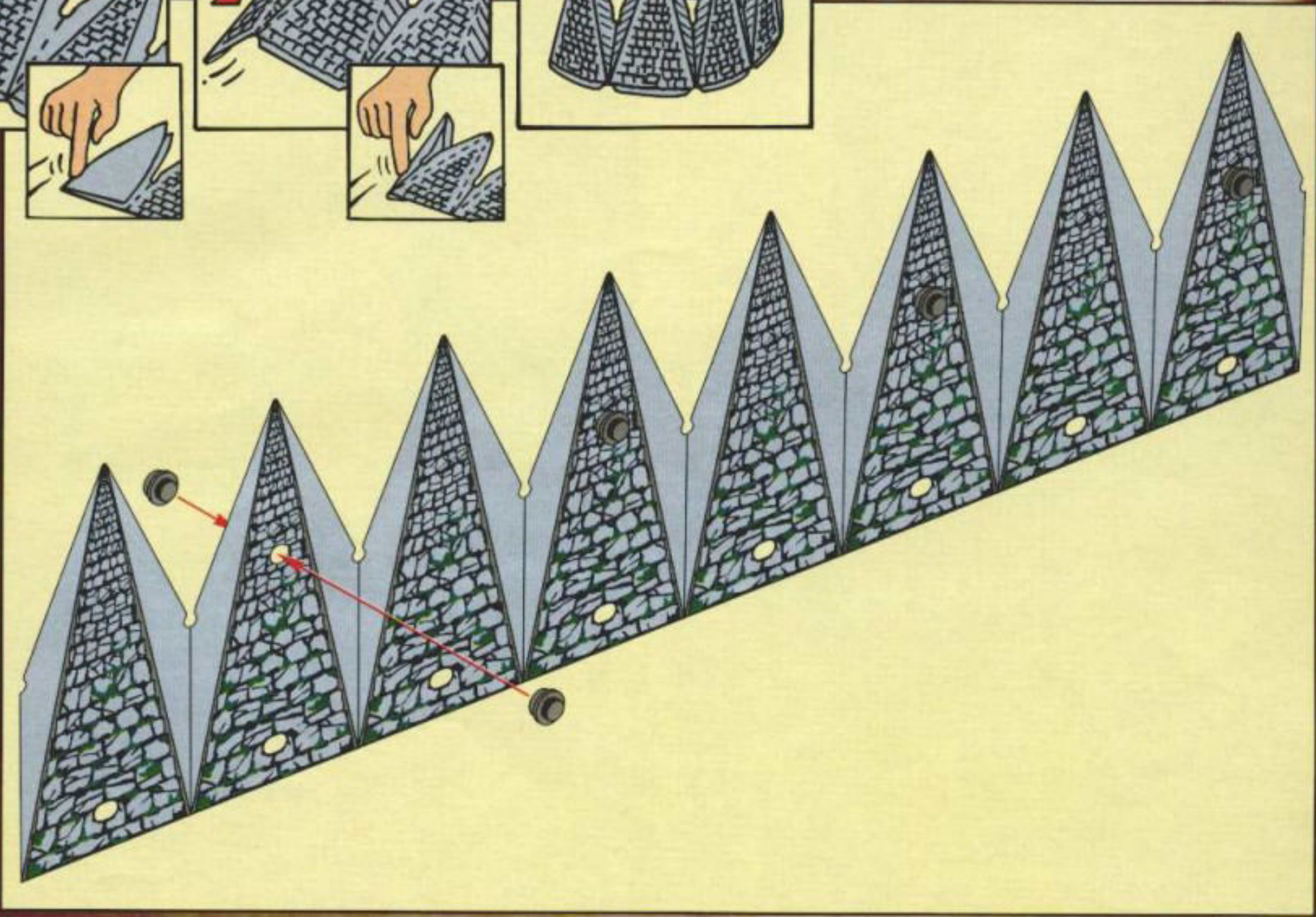
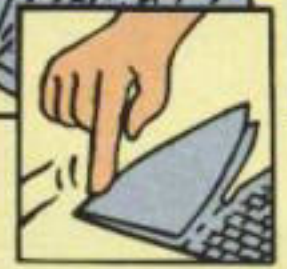
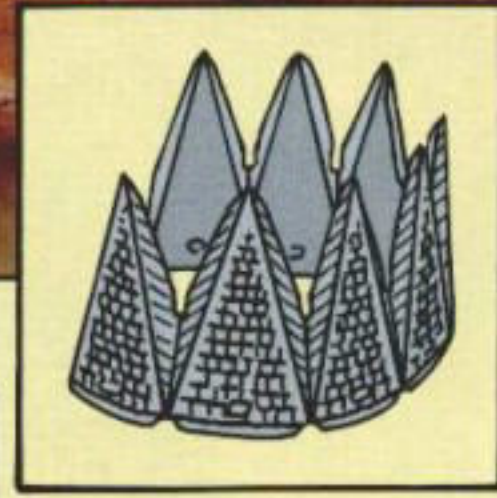
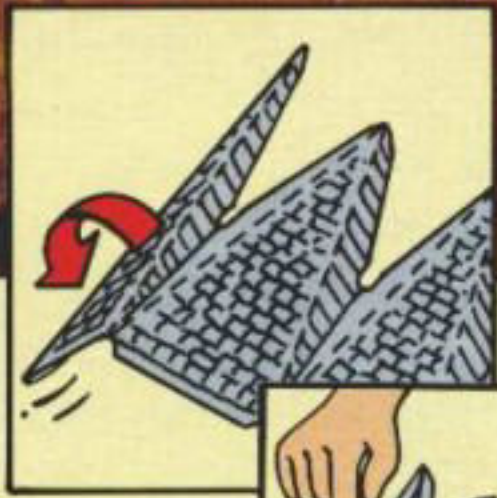

38

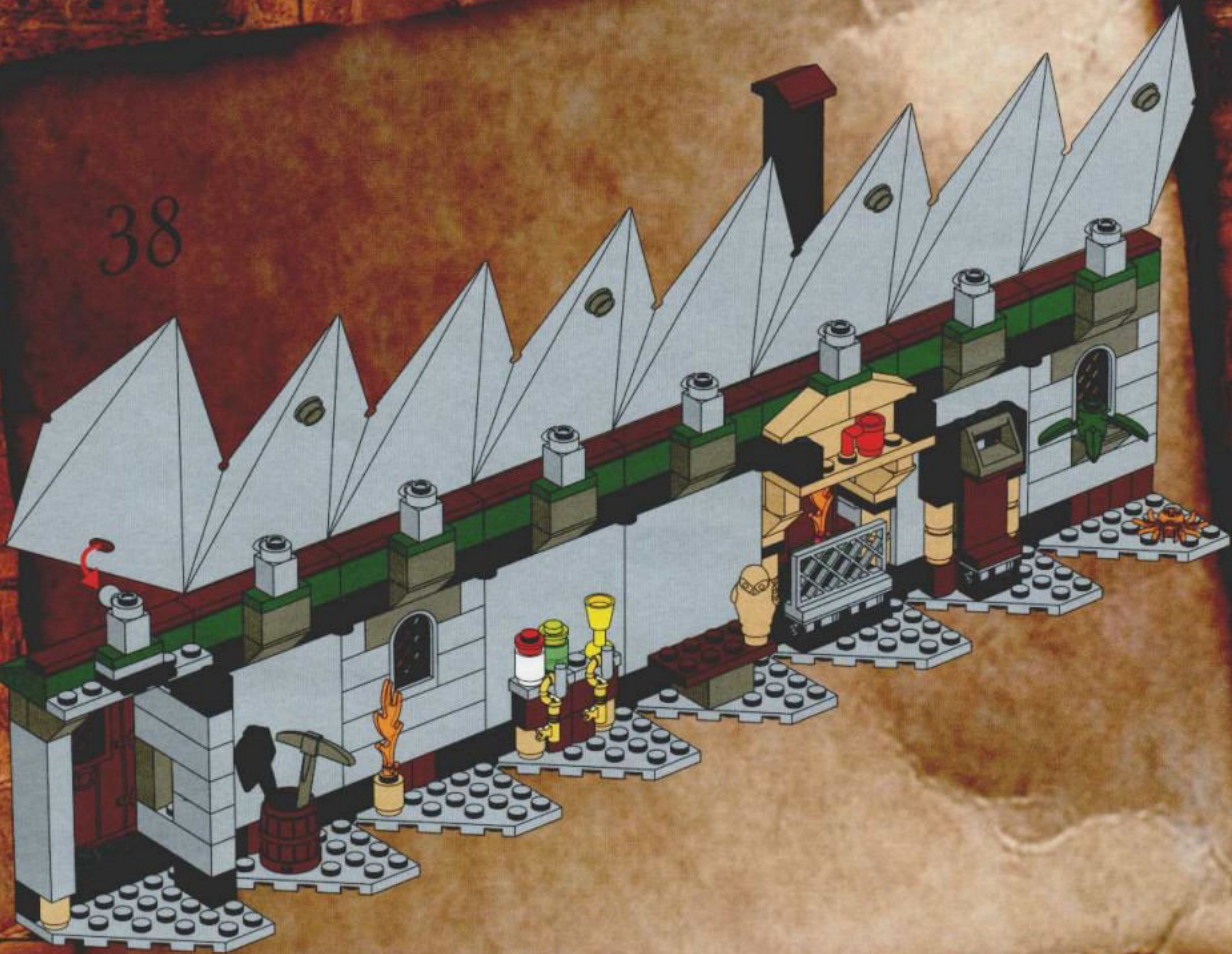

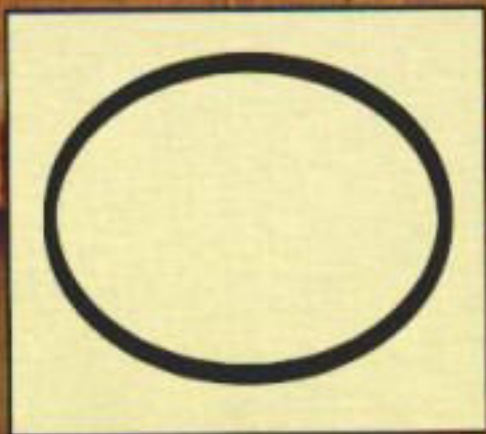
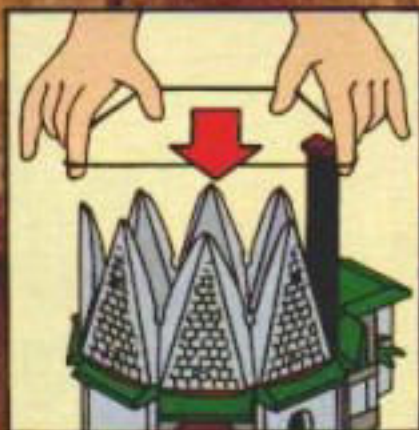

39

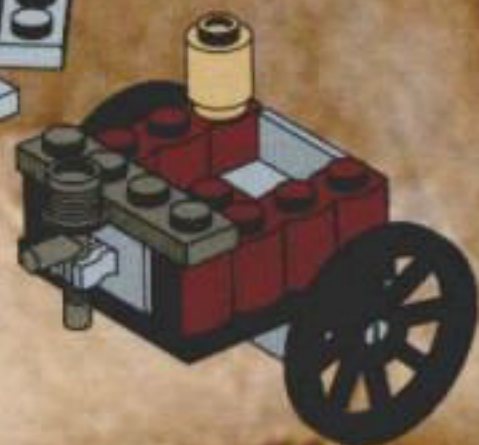
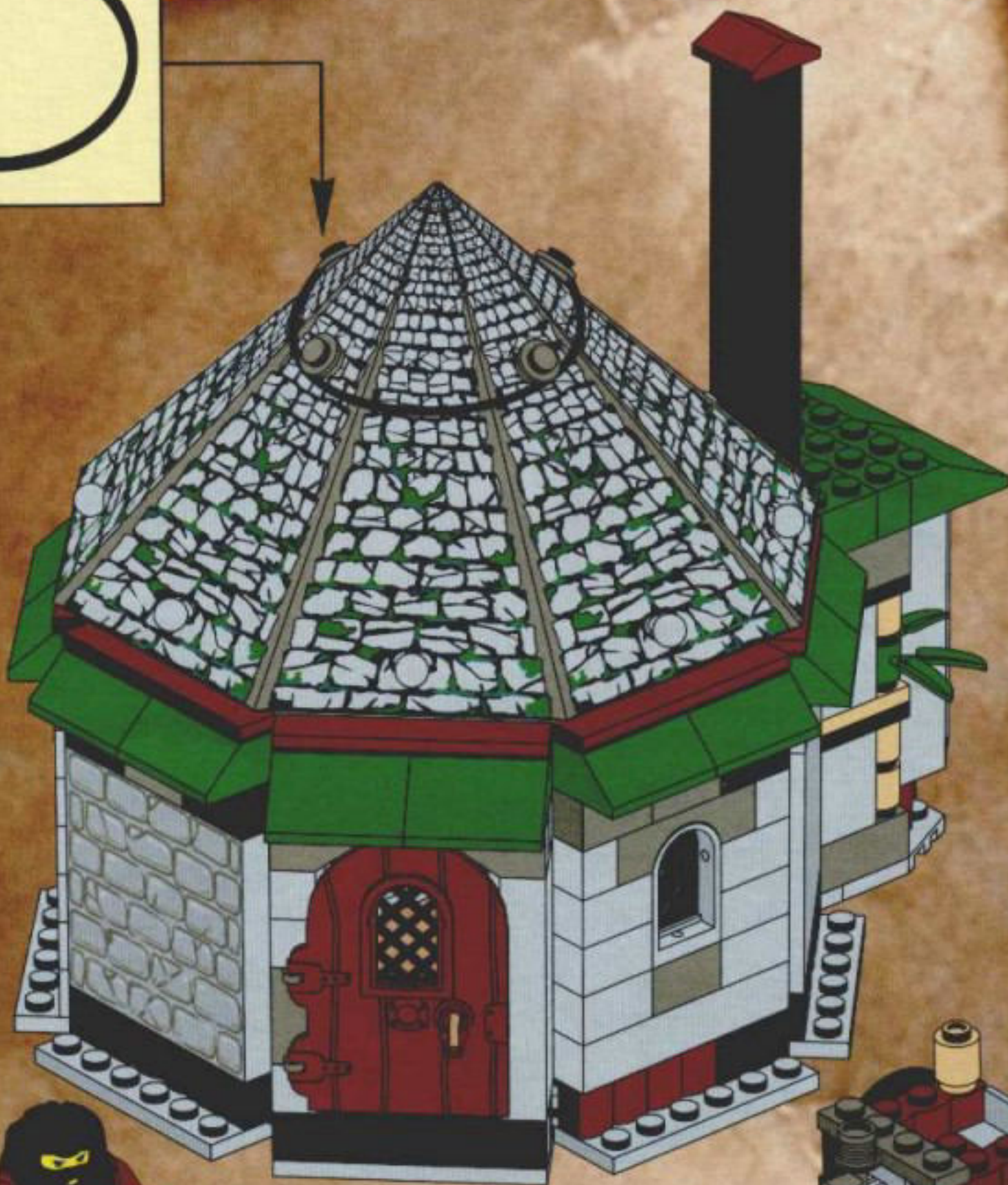



1



2

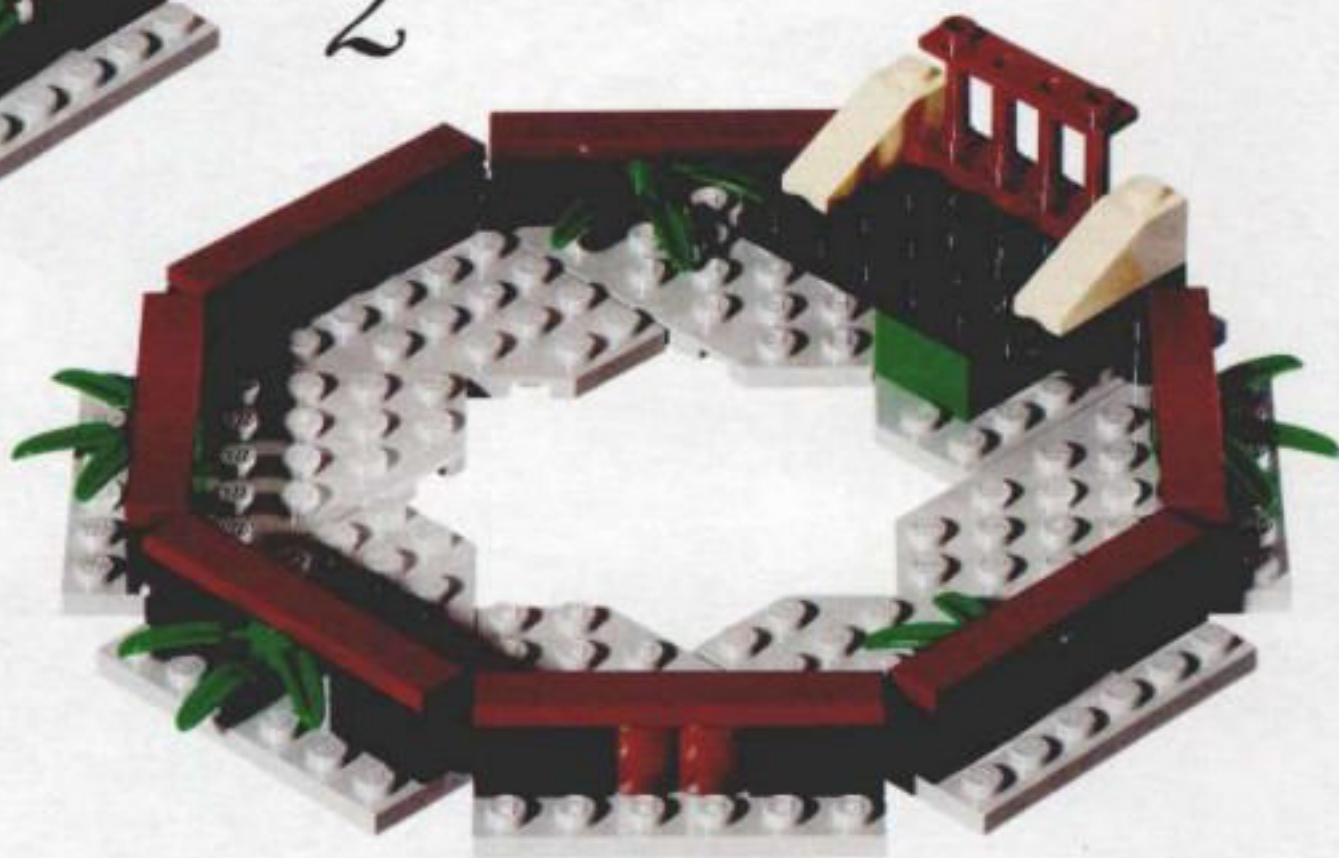

3



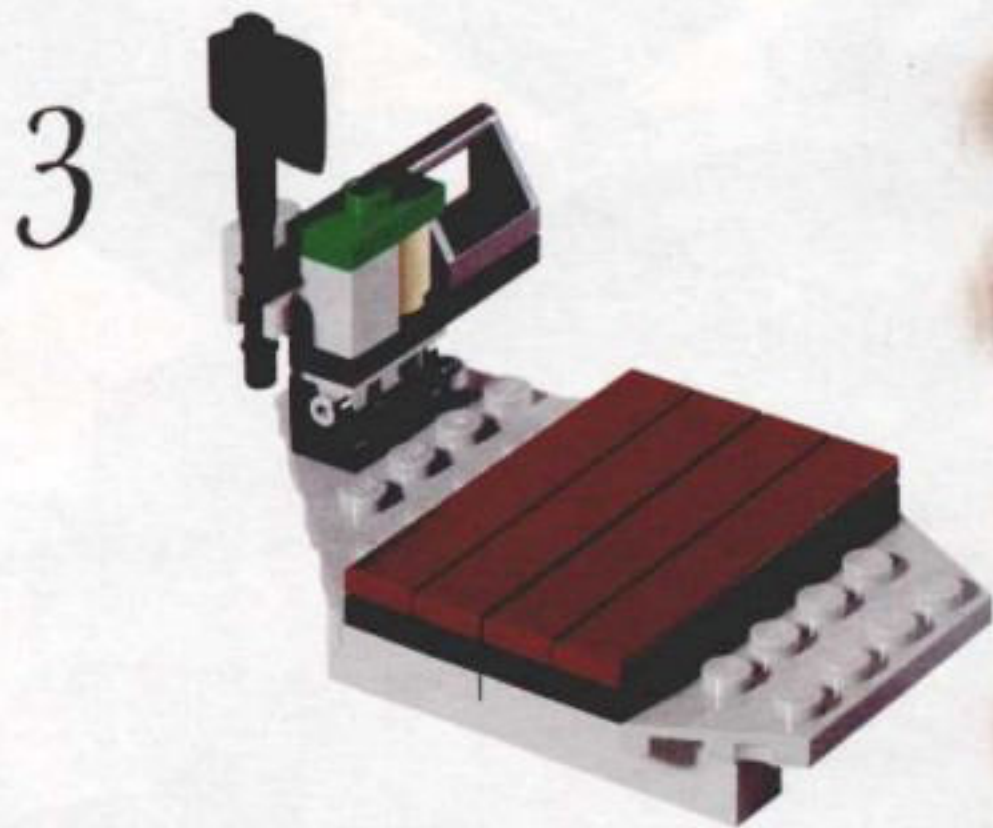
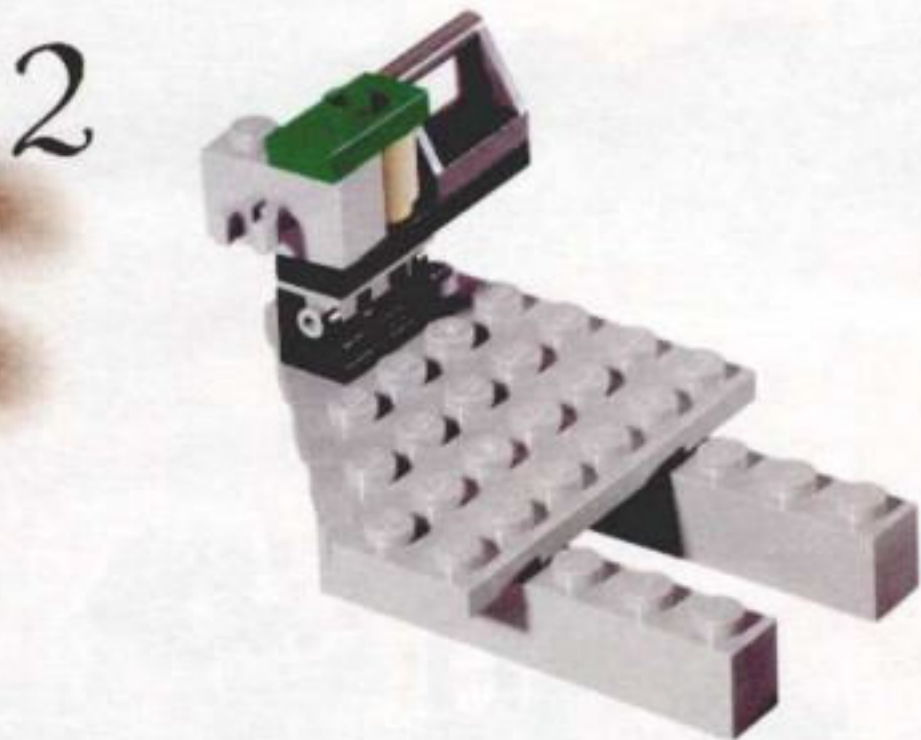

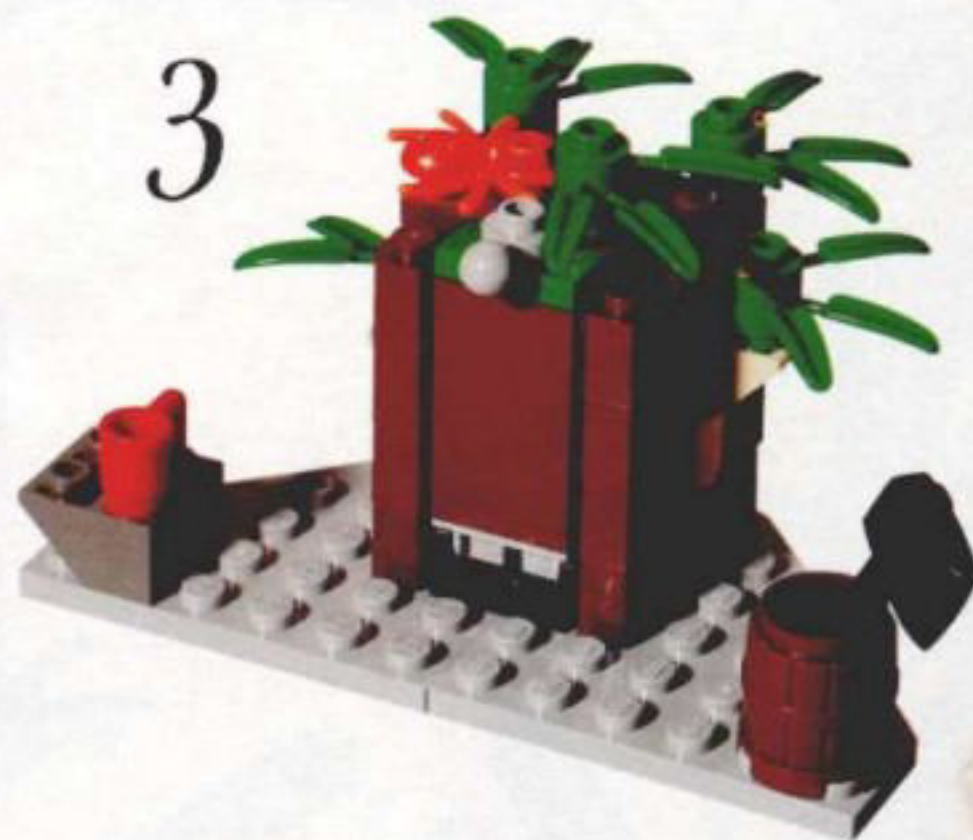
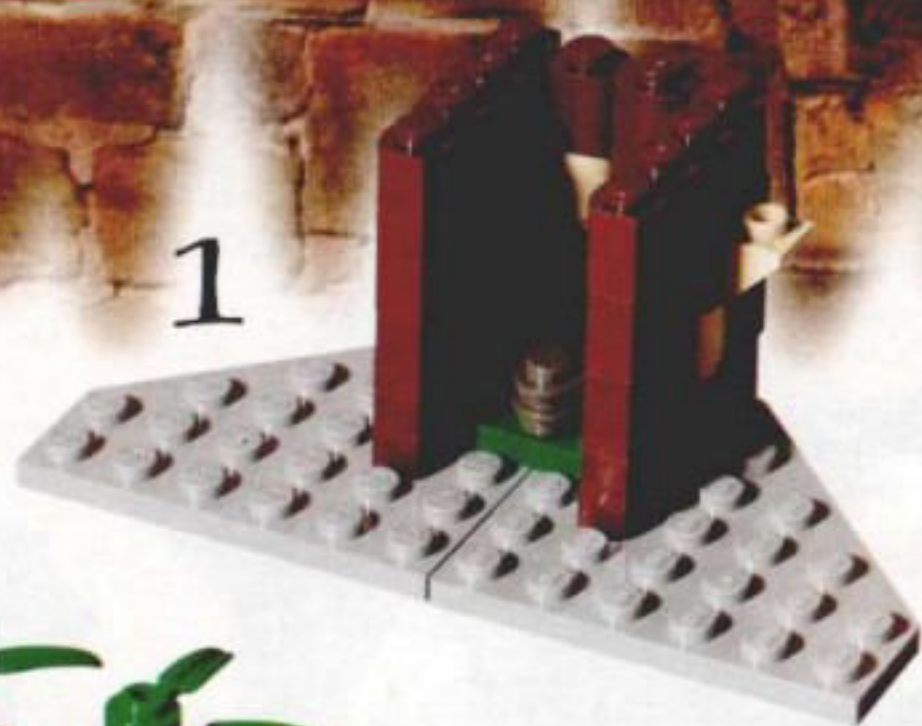

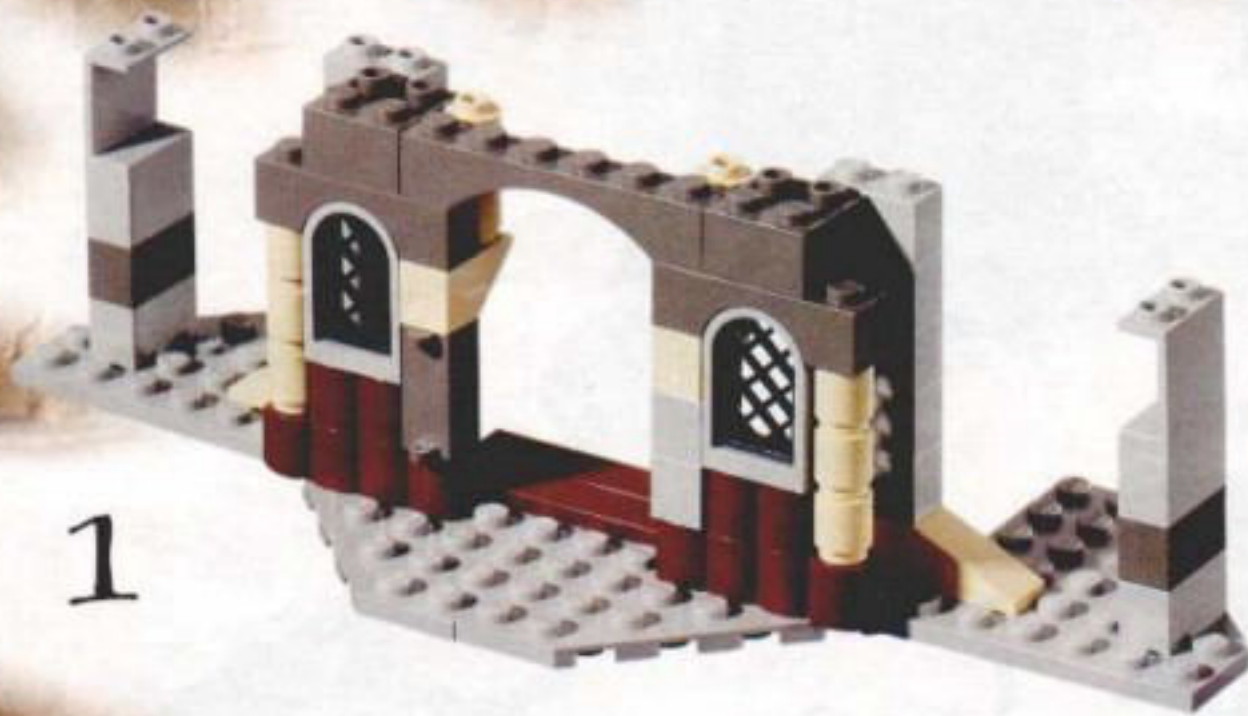

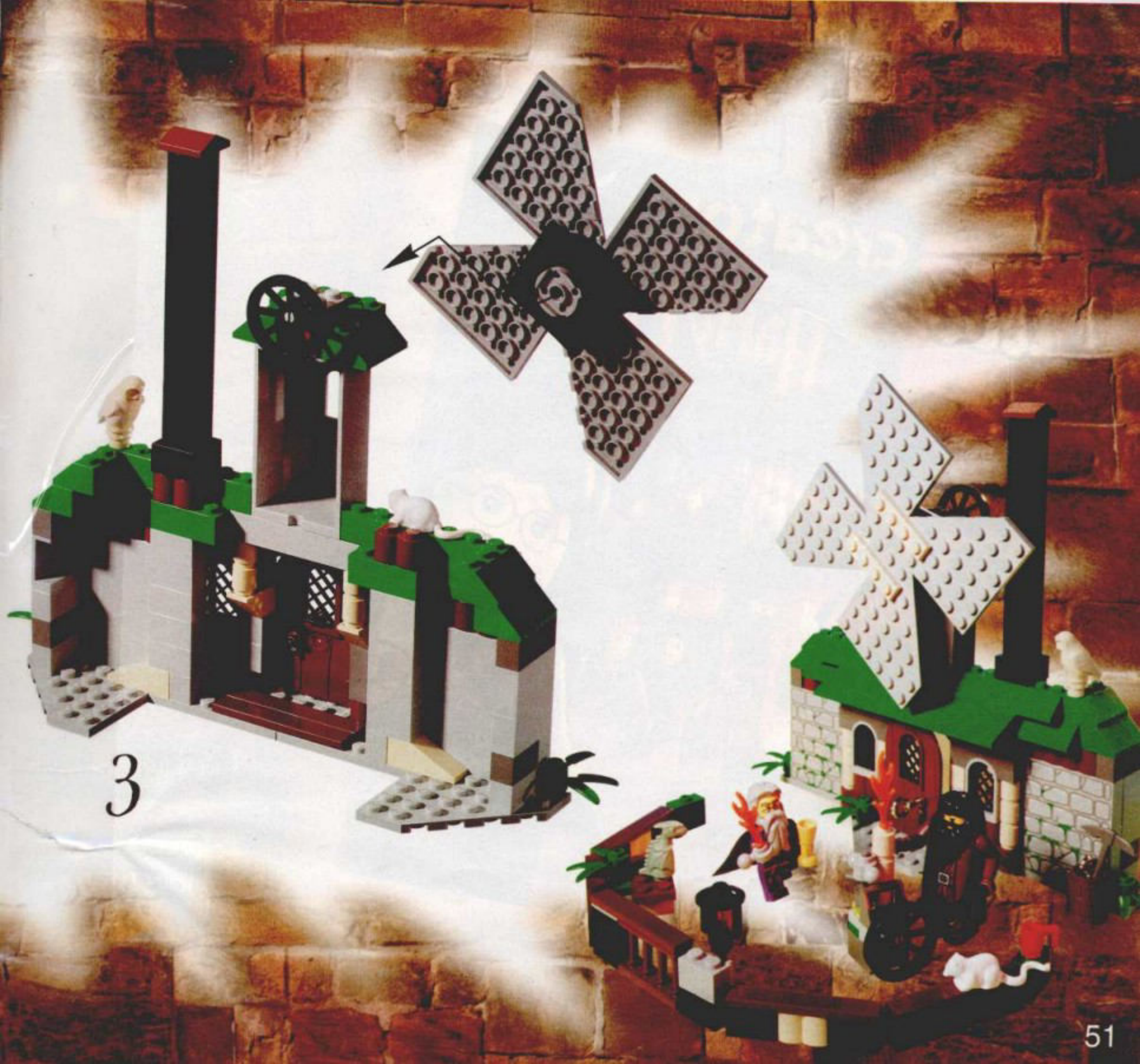

3



SOFTWARE



www.hanypotter.com



HARRY POTTER, characters, names and related indicia are trademarks of Warner Bros. © 2001
HARRY POTTER, characters, names and related indicia are trademarks of and © Warner Bros.
(2001)
WB WB SHIELD-TM & © 2001 Warner Bros.

